

## TOOL STEEL MULTI PROFILE CUTTER - 50X4MM

Not normally held in stock, delivery in a short time.

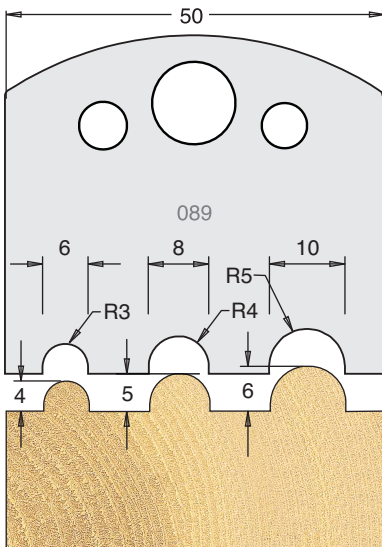

Knives	IT/33 089 50	£22.60
Limitors	IT/34 089 50	£18.90

### BLANK KNIFE

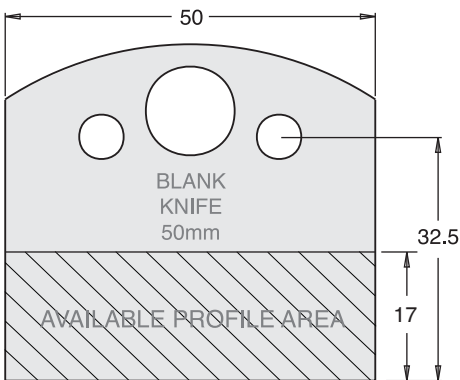

Tool Steel	IT/335 004 6	£8.34
High Speed Steel	IT/ST/HSSB02	£32.92
Limitors	IT/345 004 6	£5.22

All blades sold as a pair

## 4 PIECE PROFESSIONAL SPINDLE STARTER SET

- Hard wearing steel bodied tools in a compact carry case.
- Set comprises:
  - Disposable Insert Adjustable Groover
  - Disposable Insert Rebate Block
  - Disposable Insert Adjustable Chamfer Block
  - Multi Profile Block
- Four of the most popular spindle blocks for grooving, rebating, chamfering and profiling in softwood and hardwood and man-made board (disposable tip cutters only) on a spindle moulder.
- See relevant product pages for full details of individual blocks.



	30mm Bore	1 1/4" Bore	Stock	Price
4 pc Spindle Starter Set	IT/ST/SS001	IT/ST/SS007	Y	£848.70

### COMPRISING:

#### DISPOSABLE INSERT ADJUSTABLE GROOVER

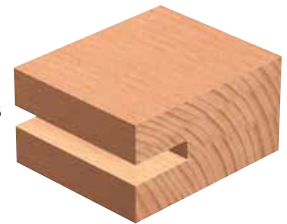
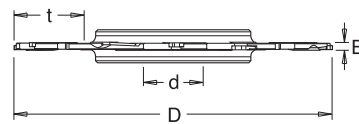

see page 28.

D	B	z	v	max. t	30mm Bore d	1 1/4" Bore d
160	4.0 - 7.5	8	4	30	IT/722 001 1	IT/722 001 7

#### DISPOSABLE INSERT REBATE BLOCK

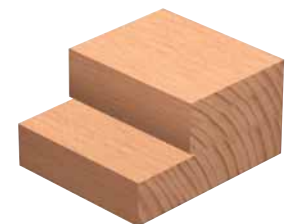
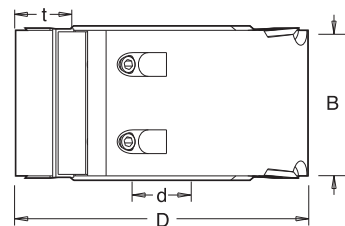

see page 32.

D	B	z	v	max. t	30mm Bore d	1 1/4" Bore d
125	50	2	4	30	IT/733 102 1	IT/733 102 7

#### DISPOSABLE INSERT ADJUSTABLE CHAMFER BLOCK

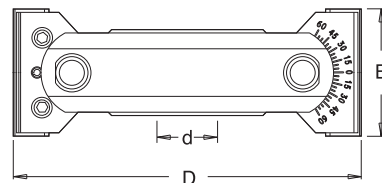

see page 38.

D	B	z	angle	30mm Bore d	1 1/4" Bore d
150	50	2	-90° to +90°	IT/734 017 1	IT/734 017 7

#### MULTI PROFILE BLOCK

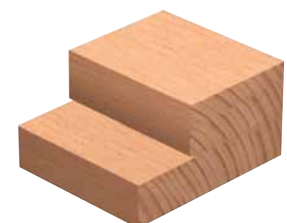
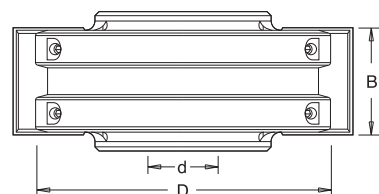

see page 57.

D	B	z	30mm Bore d	1 1/4" Bore d
114	40/50	2	IT/776 008 1	IT/776 008 7

All blades sold as a pair

All prices are exclusive of VAT