

BLANK KNIFE

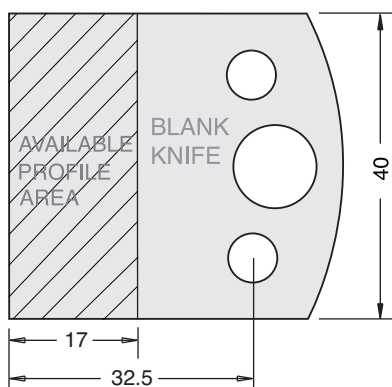

| | | |
|------------------|--------------|--------|
| Tool Steel | IT/33 000 46 | £5.97 |
| High Speed Steel | IT/ST/HSSB01 | £23.40 |
| Limitors | IT/34 000 46 | £4.42 |

MULTI PROFILE SIX PIECE CUTTER BLOCK SET

- Multi Profile Cutter Block Set complete in a wooden storage box.
- Set comes complete with profile knives and limiter plates 001 to 006 and hard wearing alloy cutter block IT/776 020 1 (30mm bore) or IT/776 010 7 (1 1/4" bore).
- Suitable for jointing, rebating and profiling in un-bonded softwood and hardwood.
- Suitable for Hand Feeding (MAN).

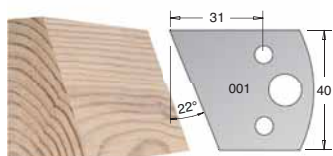

IT/33 001 40 Knives
IT/34 001 40 Limitors

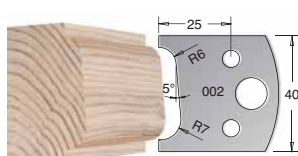

IT/33 002 40 Knives
IT/34 002 40 Limitors

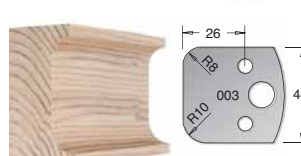

IT/33 003 40 Knives
IT/34 003 40 Limitors

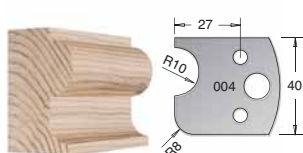

IT/33 004 40 Knives
IT/34 004 40 Limitors

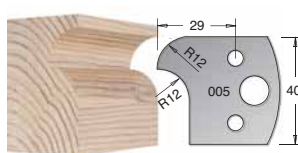

IT/33 005 40 Knives
IT/34 005 40 Limitors

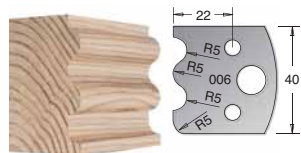

IT/33 006 40 Knives
IT/34 006 40 Limitors

| D | B | z | Profiles | 30mm Bore | 1 1/4" Bore | Stock | Price |
|-----|----|---|-----------|--------------|--------------|-------|---------|
| 100 | 40 | 2 | 001 - 006 | IT/ST/SET001 | IT/ST/SET007 | Y | £185.18 |

KEY

- Stock** - Y means normally kept in stock for next day delivery.
N means not normally held in stock, delivery in a short time.

