

# T11



## 2000 WATT VARIABLE SPEED WORKSHOP ROUTER

With built-in Quick Raiser fine height adjuster. Same features as T10 opposite but also has:

- Router fine height adjuster for above and below adjustment. One revolution of handle equals 1.5mm.
- Three quick release recesses in base to fit tables in conjunction with optional Quick Release Kit.
- Fitting for optional Clamp Guide System Kit.
- Extra large base aperture for large cutters.
- Quick release dust spout.

**T11EK** (230v) £376.85 or  
**T11ELK** (115v) £376.85

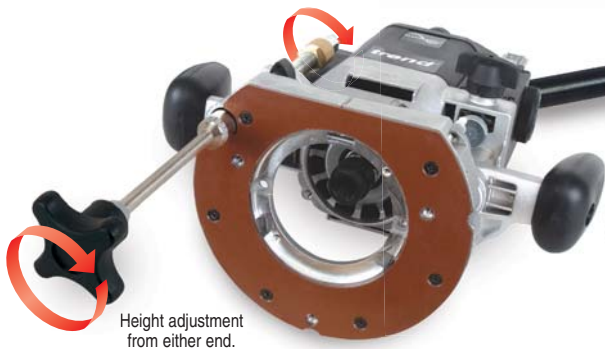

Height adjustment from either end.

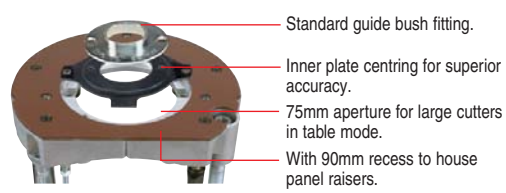

Built-in Quick Raiser for table fine height adjustment.

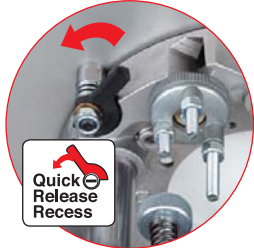

Quick Release Recess

Enables quick fitting and removal of router to PRT, router tables and jigs when used with optional Quick Release Kit. EC Design Reg. No. 000336763.



Clamp guide fitting to suit VJS clamp guides.



**INCLUDES:**

- 1 x 1/2" Collet
- 1 x Fine height adjuster
- 1 x Guide bush 30mm with inner plate and line-up pin
- 1 x Clip-in dust spout 35mm
- 1 x Side-fence with micro adjuster
- 1 x Storage case



**SPECIFICATION:**

Rating	Professional / Trade
Plunge stroke	0-80mm
Power input	2000w
Standard collet dia.	1/2"
No load speeds	8-20000 rpm
Dust spout size (ID)	35mm
Guide bush dia. supplied	30mm
Cutter dia. max. plunge/table	70/86mm
Other collet dia.	3mm, 6mm, 1/4", 8mm, 3/8", 10mm and 12mm
Weight	6.3kg
Voltages	230v or 115v*

\*All 115v routers over 1850W require a 32A BS4343 115v plug. Minimum generator or transformer requirement 3 kVA continuous with a 32A BS4343 115v socket outlet. 115v units cannot be used on the no-volt release switch CRT/MK3L and PRT/L router tables.

**T11 ACCESSORIES:**

	Product Ref.	Price
1. Quick release kit Comprising: three sets of cams, bolts & fixings	T11/JT/KIT	£27.97
2. Varijig clamp guide system kits Comprising: alloy bracket fixing & plastic slider. Allows T11 to join to Varijig Clamp Guides.	T11/VJS/CGKIT	£42.62
3. Extra side-fence	WP-T11/087	£62.37
4. Direct fit large guide bushes		
50mm	GB500	£14.67
60mm	GB600	£14.67
70mm	GB700	£14.67
5. Plug 115v 32A 32A BS4343 115 volt plug	PLUG/110V/32A	£39.44

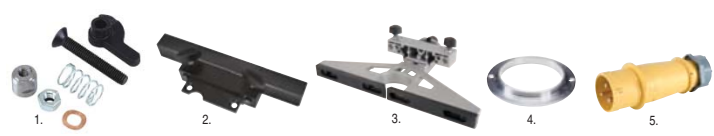

# T10

**3 YEAR WARRANTY**  
WITH ONLINE REGISTRATION



## 2000 WATT VARIABLE SPEED TRADESMAN ROUTER

Ideal for use by tradesmen in the workshop or on-site, especially for cutting worktops.

- Electronic full wave variable control of spindle speed under load for a fine finish on all types of material.
- Soft start eliminates sudden movement of machine on start-up.
- Two column precision base with large phosphor bronze bushes for plunging accuracy.
- Spindle lock and hex collet nut results in easy cutter changes with the 22mm spanner supplied.
- Adjustable twin rod parallel side-fence guide with integral micro-adjuster for straight edge work.
- Precision machined one-piece multi-slit collet for fail-safe grip of cutter shank.
- 3 position revolving depth stop for fast adjustable settings.
- Adjustable inner plate for guide bush accuracy.

**T10EK** (230v) £336.41 or  
**T10ELK** (115v) £336.41



**T10 UNIQUE FEATURE IDEAL FOR ROUTING KITCHEN WORKTOPS**

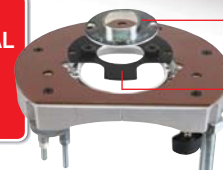

POWER TOOLS, SAFETY & TABLES

### INCLUDES:

- 1 x 1/2" Collet
- 1 x Guide bush 30mm with inner plate and line-up pin
- 1 x Bolt-on dust spout 35mm
- 1 x Side-fence with micro adjuster
- 1 x Storage case



### SPECIFICATION:

Rating	Professional / Trade
Plunge stroke	0-80mm
Power input	2000w
Standard collet dia.	1/2"
No load speeds	8-20000 rpm
Dust spout size (ID)	35mm
Guide bush dia. supplied	30mm
Cutter dia. max.	50mm
Other collet dia.	3mm, 6mm, 1/4", 3/8", 8mm, 10mm & 12mm
Weight	6.3kg
Voltages	230v or 115v*

\*All 115v routers over 1850W require a 32A BS4343 115v plug. Minimum generator or transformer requirement 3 kVA continuous with a 32A BS4343 115v socket outlet.

### T10 & T11 REPLACEMENT PARTS:

These routers are supported by our network of repair agents around the UK. A complete range of spares are available. Common spares listed below.

	Product Ref.	Price
1. Collet nut	CLT/NUT/T10	£10.13
2. Brush set (pair)		
230v, pre 10/09	WP-T10E/004	£16.60
115v, pre 10/09	WP-T10EL/004	£16.60
230v, post 10/09	WP-T10E/004A	£16.60
115v, post 10/09	WP-T10EL/004A	£16.60
3. Spring for thumb knob	WP-T10/081	£1.69
4. Thumb knob M6x15mm	WP-T10/085	£2.30
5. Inner plate		
T10	WP-T10/075	£7.52
T11	WP-T9/075	£6.06
6. Switch unit (115v and 230v)	WP-T10E/003	£39.49
7. Guide bush screw M5x8mm (each)	WP-SCW/09	£0.72
8. Inner plate screw M5x12mm (each)	WP-SCW/42	£0.72
9. Handles		
Left	WP-T10/041	£8.96
Right	WP-T10/049	£8.96
10. Plastic slider base		
T10	WP-T10/080	£18.53
T11	WP-T11/080	£18.53
11. T11 fine height adjuster handle	WP-T11/128	£14.05
11a. Storage case	CASE/T10	£42.62

### ACCESSORY GUIDE BUSHES

From 10mm to 40mm see page 183 for full details.

Product Ref.  
GB group



### T10 & T11 ACCESSORIES:

	Product Ref.	Price
12. Guide bush 30mm x 10mm spigot	GB30/A	£8.96
13. Collets precision slit one-piece sizes:		
3mm	CLT/T10/3	£42.02
6mm	CLT/T10/6	£27.97
1/4"	CLT/T10/635	£27.97
8mm	CLT/T10/8	£27.97
3/8"	CLT/T10/95	£27.97
10mm	CLT/T10/10	£27.97
12mm	CLT/T10/12	£27.97
1/2"	CLT/T10/127	£27.97
14. Beam trammel 10mm x 500mm rod	BEAM/002	£26.16
15. Standard fence rods 360mm (pair)	ROD/10X360	£19.13
16. Extra long fence rods 500mm (pair)	ROD/10X500	£26.16
17. Plug 115v 32A 32A BS4343 115 volt plug	PLUG/110V/32A	£39.44
18. Socket 115v 32A 32A BS4343 115 volt plug	SOCK/110V/32A	£36.33
19. Line up pin 12mm / 1/2"	WP-T9/090	£5.08

### T10 ACCESSORIES:

	Product Ref.	Price
20. Fine height adjuster	FHA/003	£26.16
21. Extra side-fence	WP-T10/087	£69.00
22. Direct fit guide bushes		
30mm	GB/T10/30	£17.81
40mm	GB/T10/40	£17.81



# T5v2

## 1000 WATT VARIABLE SPEED ROUTER

A popular design, this router is both compact, powerful and suitable for light and medium duty applications.

- Electronic variable control of spindle speed under load for a fine finish on all types of material.
- Soft-start feature eliminates sudden movement of machine on start-up.
- Spindle lock and hex collet nut allows easy cutter changes.
- Precision machined one piece multi-slit collet with combined nut.
- Compact design and low weight make it easy to use especially for intricate work.
- Adjustable twin rod side-fence for guiding along a straight edge.

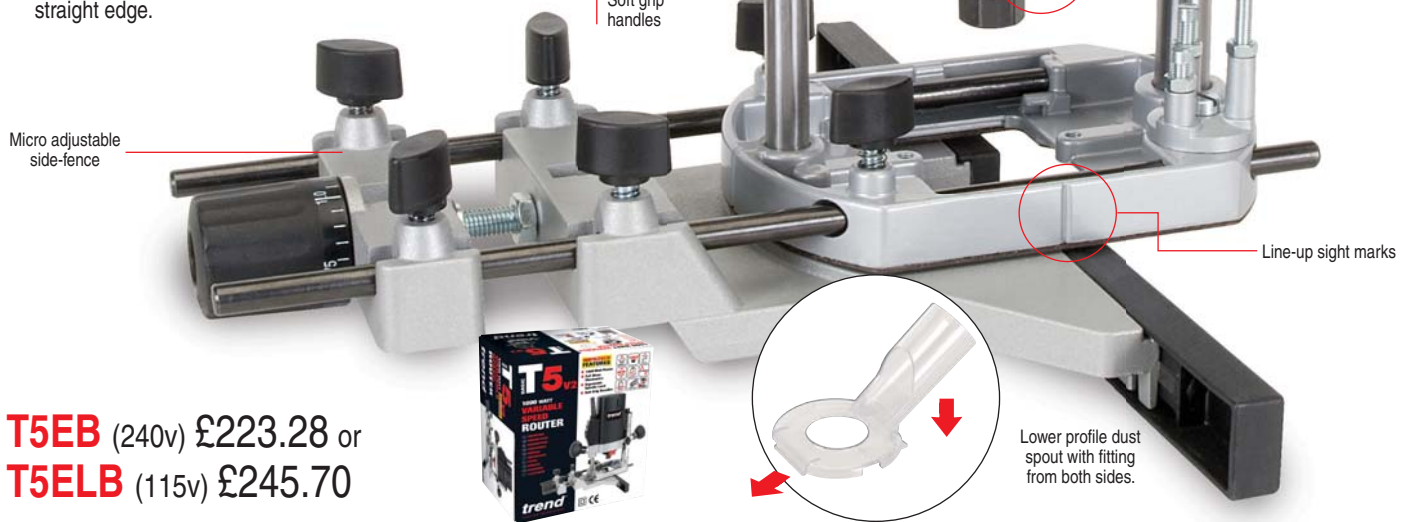

**T5EB** (240v) £223.28 or  
**T5ELB** (115v) £245.70



### INCLUDES:

- 1 x 1/4" (6.35mm) Collet
- 1 x 35mm Clip-in dust spout
- 1 x 20mm Guide bush
- 1 x Side-fence with micro adjuster
- 1 x Beam trammel attachment



### SPECIFICATION:

Rating	Professional / Trade
Plunge stroke	0-50mm
Power input	1000w
Standard collet dia.	1/4" & 8mm
Cutter dia. max.	40mm
No load speeds	9-27000 rpm
Dust spout size (ID)	35mm
Guide bush dia.	20mm
Weight	3.3kg
Voltages	240v or 115v*

\* For 115V minimum generator or transformer requirement 2.75kVA continuous.

### T5 REPLACEMENT PARTS:

The T5 router is supported by our network of repair agents around the UK. A complete range of spares are available. Common spares listed below.

	Product Ref.	Price
8. <b>Brush Set:</b>		
240v (pair)	<b>WP-T5E/032</b>	£8.96
115v (pair)	<b>WP-T5EL/032</b>	£9.63
9. <b>Spring for thumb knob</b>	<b>WP-T5/016</b>	£1.33
10. <b>Thumb knob M6x12mm</b>	<b>WP-T5/011</b>	£1.94
11. <b>Switch (version 1)</b>		
240v	<b>WP-T5E/027</b>	£12.11
115v	<b>WP-T5EL/027</b>	£15.25
12. <b>Switch (version 2)</b>		
240v & 115v	<b>WP-T5E/017</b>	£12.11
13. <b>Grip handle (version 2)</b>	<b>WP-T5/015A</b>	£5.82
14. <b>Guide bush screw M5x10mm</b>	<b>WP-SCW/13</b> (ea)	£0.72
15. <b>Plastic slider base</b>	<b>WP-T5/050</b>	£6.78
16. <b>Depth stop</b>	<b>WP-T5/014</b>	£3.28
17. <b>Beam trammel attachment</b>		
For 8mm dia. fence rods.	<b>BEAM/005</b>	£7.64
18. <b>Guide bush 20mm</b>	<b>GB20</b>	£8.36
19. <b>Collet &amp; nut sets (new style post 2005)</b>		
Multi-slit one-piece collet with combined nut sets in 3 sizes.		
ID 1/4"	<b>CNS/T5/635</b>	£18.85
ID 8mm	<b>CNS/T5/8</b>	£18.85
20. <b>Collet (old style pre 2005)</b>		
For use with old style collet nut.		
ID 1/8"	<b>CLT/T5/32</b>	£37.31

### T5 ACCESSORIES:

	Product Ref.	Price
1. <b>Fine height adjuster</b>		
Fits in place of the depth stop and threads onto the longest revolving turret screw. Provides fine height adjustment in a router table or with dovetail jigs.	<b>FHA/001</b>	£15.25
2. <b>Guide bushes</b>		
Alternative guide bushes to fit base of router. From 10mm to 40mm. See page 183 for complete range.	<b>GB10, GB12, GB14</b>	£8.36
3. <b>Beam trammel 8mm x 500mm rod</b>	<b>BEAM/001</b>	£17.81
4. <b>Extra side-fence</b>	<b>WP-T5/046</b>	£38.05
5. <b>Side-fence without micro adjustment</b>	<b>WP-T5/077</b>	£21.68
6. <b>Standard fence rods 300mm (pair)</b>	<b>ROD/8X300</b>	£12.73
7. <b>Extra long fence rods 500mm (pair)</b>	<b>ROD/8X500</b>	£20.34



# T4

## 850 WATT VARIABLE SPEED ROUTER

Light duty plunge router for the hobbyist, DIY'er and light trade user.

- Variable speed control.
- Spindle lock.
- Hex collet nut allows easy cutter changes.
- Removable base for carving and die grinding with 43mm diameter collar for pillar drill fitment.
- Tapped fixing holes for Trend standard guide bushes.
- Separate dust spout fixing holes.
- Adjustable twin rod side-fence for guiding along a straight edge.

**T4EK** (240v) £102.92 or  
**T4ELK** (115v) £102.92



### INCLUDES:

- 1 x 1/4" Collet
- 1 x 6mm Collet
- 1 x 8mm Collet
- 1 x 34mm Bolt-on dust spout
- 1 x 16mm Guide bush
- 1 x Side-fence
- 1 x Storage case



Removable base for shaping & sharpening. Use Burrs & Rasps for grinding & carving, see page 78 for full details.



Edge moulding



Hinge recessing with a Hinge Jig & Unibase fitted or use Ref. GB/T4/160.

### SPECIFICATION:

Rating	Hobbyist / DIY / light trade
Plunge stroke	0-35mm
Power input	850w
Standard collet dia.	1/4", 6mm & 8mm
Dust spout size (ID)	34mm
Guide bush dia.	16mm
No load speeds	11,500 - 32,000 rpm
Cutter dia. max.	30mm
Weight	2.4kg
Voltage	230v or 115v

For 115v minimum generator or transformer requirement 2.75kVA continuous.

### T4 ACCESSORIES:

	Product Ref.	Price
1. Fine height adjuster		
Fits in place of the depth stop and threads onto the longest revolving turret screw. It provides a fine height adjustment of the cutter in a router table or with a dovetail jig.		
	<b>FHA/009</b>	£13.93
2. Guide bushes	<b>GB10, GB12, GB14</b>	£8.36
Alternative guide bushes to fit base of router. From 10mm to 40mm. See page 183 for complete range.		
3. Beam trammel	<b>BEAM/001</b>	£17.81
4. Extra long fence rods	<b>ROD/8X500</b>	£20.34
5. Side-fence		
Complete with rods <b>WP-T4/087</b> £10.82		

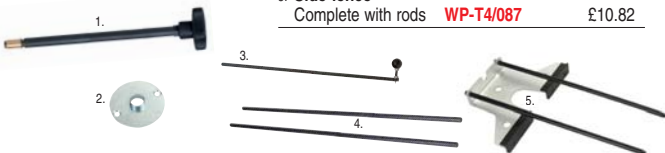

### REPLACEMENT PARTS:

	Product Ref.	Price
6. Collet nut	<b>CLT/NUT/T4</b>	£4.24
7. Collet spring	<b>WP-T4/033</b>	£1.33
8. Brush set (pair)		
230v	<b>WP-T4E/010</b>	£4.24
115v	<b>WP-T4EL/010</b>	£4.24
9. Thumb knob	<b>WP-T4/038</b>	£1.33
10. Spring for thumb knob	<b>WP-T4/039</b>	£0.72
11. Guide bush screw (ea)	<b>WP-SCW/09</b>	£0.72
12. Depth stop rod	<b>WP-T4/036</b>	£1.33



### Product Ref. Price

13. Switch 230v	<b>WP-T4E/017</b>	£2.90
115v	<b>WP-T4EL/017</b>	£2.56
14. Grip handle	<b>WP-T4/046</b>	£2.44
15. Plastic slider base	<b>WP-T4/061</b>	£1.94
<b>16. Replacement one piece collets</b>		
ID 3mm	<b>CLT/T3/3</b>	£4.85
ID 6mm	<b>CLT/T4/6</b>	£4.85
ID 1/4"	<b>CLT/T4/635</b>	£4.85
ID 8mm	<b>CLT/T4/8</b>	£4.85
<b>17. Storage Case</b>		
Size: 415 x 290 x 140mm <b>CASE/T4</b> £14.42		

