

# ROUTER CUTTER SETS



## 12 PIECE DOLLS HOUSE SET 1/4" SHANK

**TCT**  
TUNGSTEN  
CARBIDE  
TIPPED

Designed to suit dolls houses at 1:12 scale and for all types of miniature or small scale work.

Moulds are machined on a wide piece of stock and then cut off using a mini circular saw.

- ▲ It is advisable that the router is held inverted in a table with a small aperture in the table and fence.
- ▲ Extra care must be taken when setting up to ensure the required mould is created.

**SET/DH1X1/4TC** £135.45

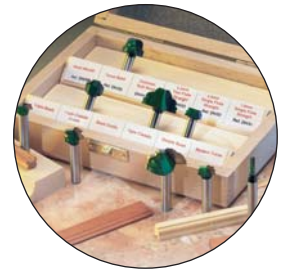

Supplied in a wooden storage box.

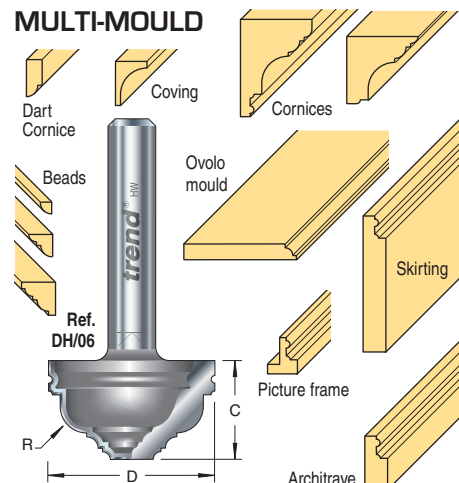
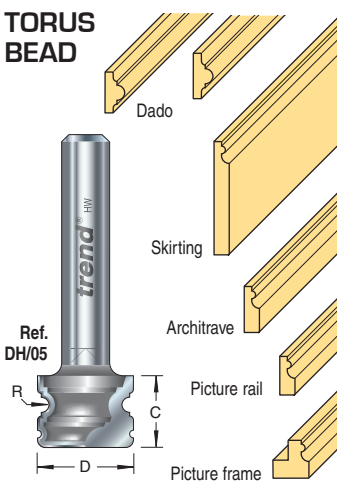
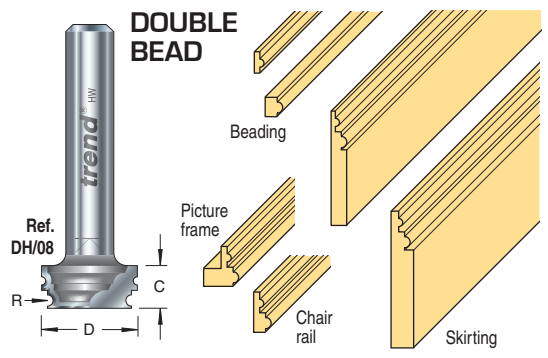
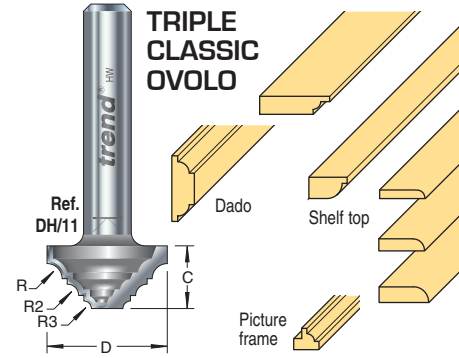
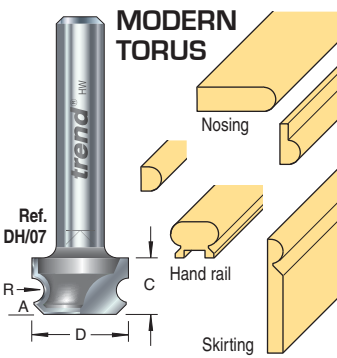
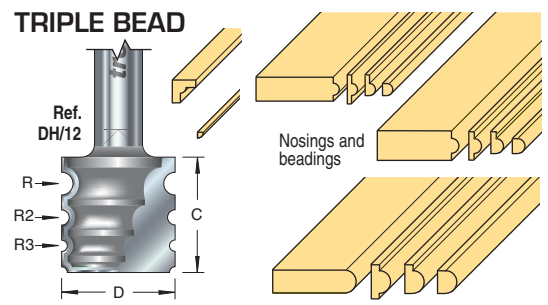
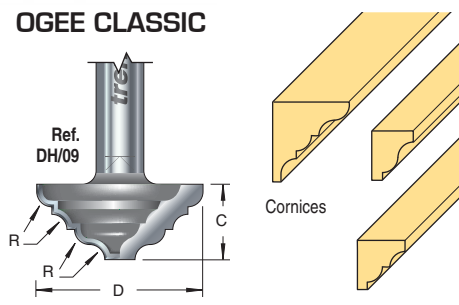
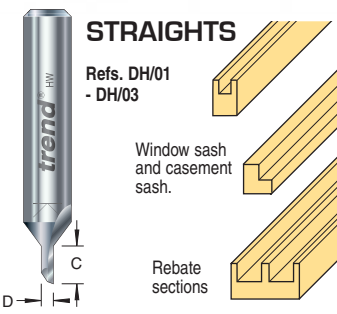

### REPLACEMENT CUTTERS

D mm	C mm	A Deg.	R mm	R2 mm	R3 mm	Product Ref.	Shank Dia. 1/4"
1.6	5.0	-	-	-	-	DH/01	£14.53
2.0	5.0	-	-	-	-	DH/02	£14.53
3.2	8.0	-	-	-	-	DH/03	£14.53
12.7	7.0	-	1.0	-	-	DH/04	£29.91
12.7	9.5	-	1.0	-	-	DH/05	£29.91
22.0	13.0	-	3.5	-	-	DH/06	£33.90
12.7	7.5	45°	1.6	-	-	DH/07	£29.05
12.7	5.5	-	0.8	-	-	DH/08	£36.94
22.0	10.0	-	2.0	-	-	DH/09	£36.94
12.7	5.1	45°	-	-	-	DH/10	£23.60
15.9	8.3	-	2.0	1.5	1.0	DH/11	£36.94
15.0	15.2	-	1.5	1.0	0.75	DH/12	£36.94

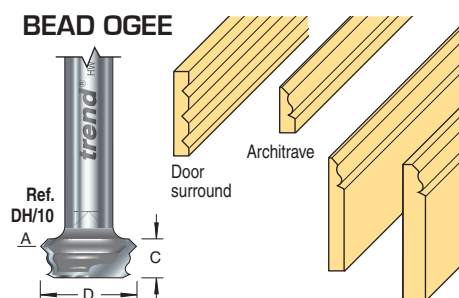
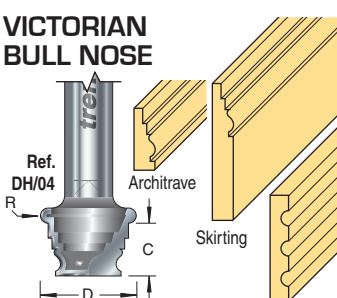

### HAND MITRE SHEARS

For perfect mitre cuts of delicate mouldings, beadings and weatherseals. Can be used on mouldings up to 10mm thick. See page 218 for full details.



Product Ref.  
**HM/SHEAR**  
**HM/SHEAR/A**



# 1/4" & 1/2" SHANK 6 PIECE SET



For decorative woodworking, such as grooving, profiling and moulding.

- Includes 3 self-guided cutters for straight and shaped work.
- For softwoods, hardwoods, MDF and plywood.

**SET/SS11X1/4TC**

£21.69

**SET/SS11X1/2TC**

£21.69

**TWO FLUTE**

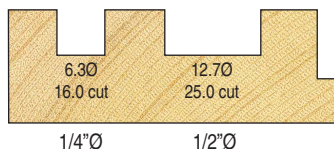

**GUIDED OGEE**

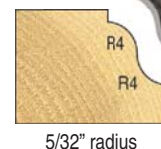

**GUIDED ROUND OVER**

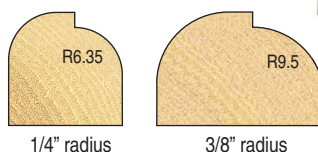

**'V' GROOVE**

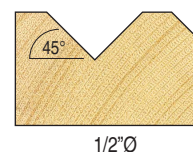

# 1/4" SHANK 12 PIECE SET



Contains a range of the most widely used cutters for decorative woodworking.

- For softwood, hardwood, chipboard, plywood and MDF.
- Includes seven self-guided cutters for decorating edge moulding of straight and curved components.

**SET/SS8X1/4TC**

£34.39

**TWO FLUTE**

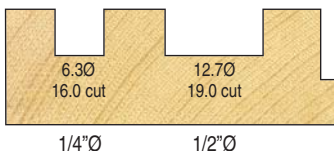

**GUIDED REBATER**

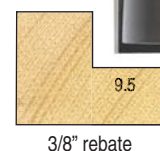

**GUIDED TRIMMER**

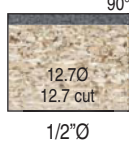

**'V' GROOVE**

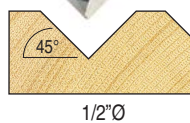

**GUIDED CHAMFER**



**GUIDED OGEE**

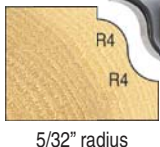

**GUIDED COVE**

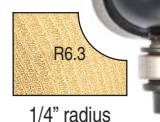

**CORE BOX**



**GUIDED ROUND OVER**

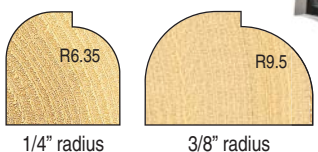

**DOVETAIL**

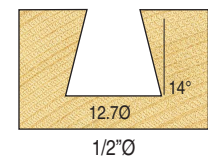

Cutters tilt up for choosing and easy access.







Grooving with a two flute. Ogee cutter fitted in a router. Rounding over a mould.

**TCT**  
TUNGSTEN  
CARBIDE  
TIPPED



# 1/2" SHANK 15 PIECE SET

A fifteen piece set containing a selection of popular cutters.

- For softwood, hardwood, chipboard, plywood and MDF.
- Includes eight self-guided cutters for straight and shaped work.

**SET/SS9X1/2TC**

£48.32



### SINGLE FLUTE

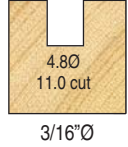

### TWO FLUTE

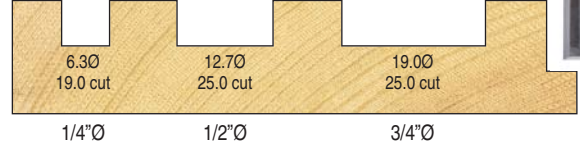

### GUIDED TRIMMER



### GUIDED REBATER

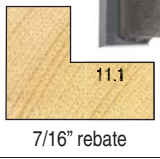

### DOVETAIL

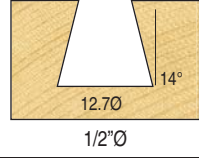

### GUIDED ROUND OVER

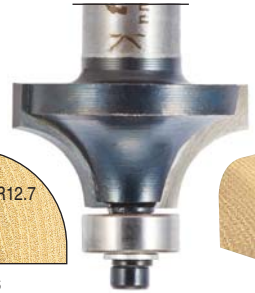

### CORE BOX

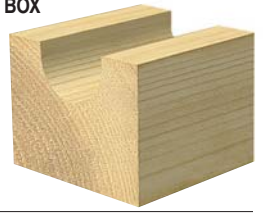

### GUIDED CHAMFER

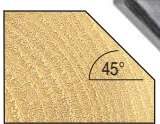

### GUIDED COVE

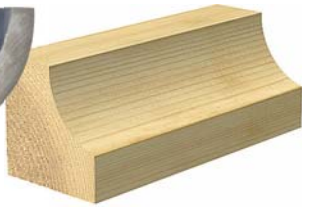
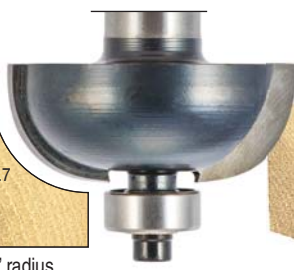
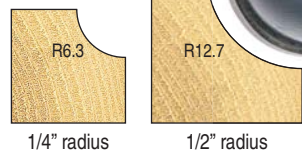

### GUIDED OGEE

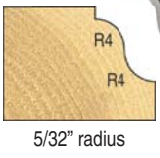

### 'V' GROOVE

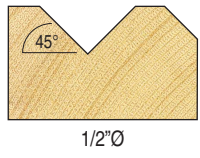



# 1/4" SHANK 24 PIECE SET



Cutters tilt up for choosing and easy access.

Contains a range of widely used cutters for decorative woodworking.

- For softwood, hardwood, chipboard, plywood and MDF.
- Excellent value for money.
- Includes eleven self-guided cutters for straight and shaped work.
- Supplied in plastic carry case.



## TWO FLUTE

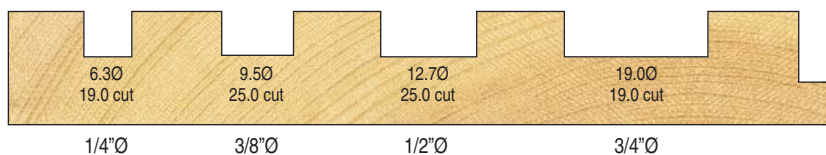

## GUIDED ROUND OVER

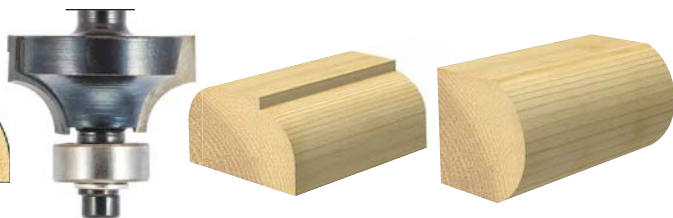
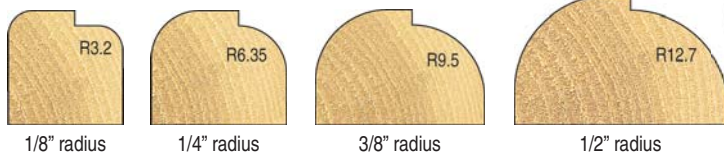

## GUIDED CHAMFER

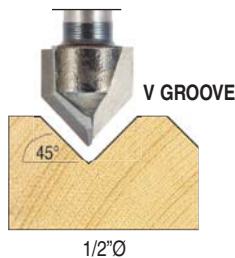

## GUIDED COVE

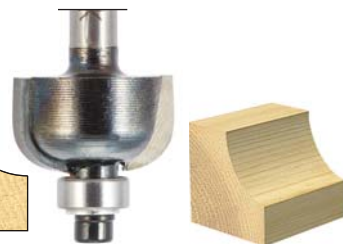
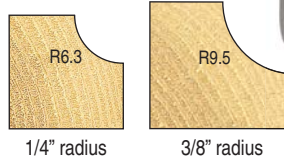

## GUIDED TRIMMER



## GUIDED REBATER

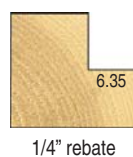

## KEYHOLE

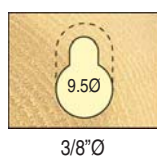

## PIERCE & TRIM

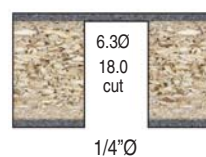

## CORE BOX

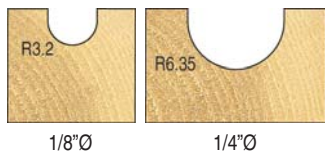

## OVOLO PANEL

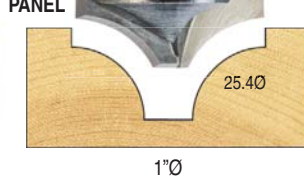

## GUIDED ROMAN OGEE

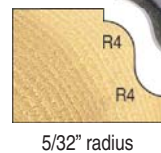

## STAFF BEAD

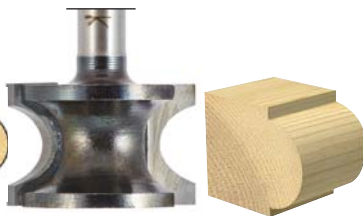
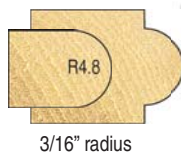

## HINGE RECESS

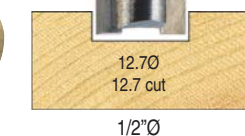

## DOVETAIL

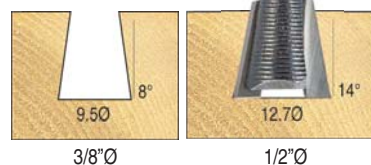



# 1/2" SHANK 35 PIECE SET



This 35 piece cutter set contains a concise selection of the most widely used cutters for decorative and professional woodworking. Supplied in an aluminium carry case.

- Suitable for grooving, profiling and moulding.
- Set includes seven straights from 3.2mm to 19mm diameter and twenty-one bearing guided cutters for straight and shaped work.
- Use on softwoods, hardwoods, MDF and plywood.
- Excellent value for money.

**SET/SS35X1/2TC**  
£92.35



Supplied in an aluminium carry case.



## SINGLE FLUTE

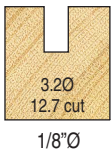

## TWO FLUTE

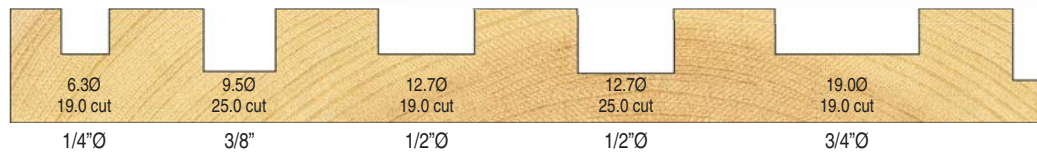

## HINGE RECESS

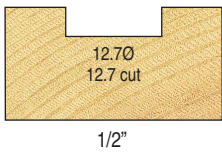

## GUIDED CHAMFER

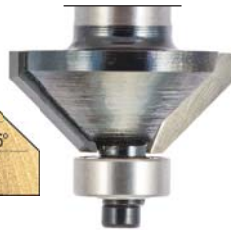
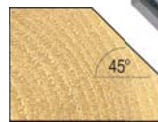

## GUIDED TRIMMER

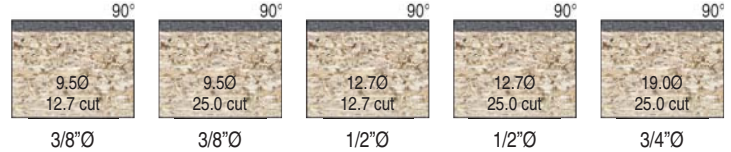

## GUIDED COVE

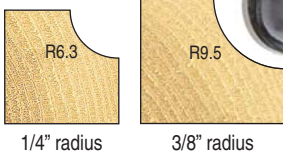

## PIERCE & TRIM

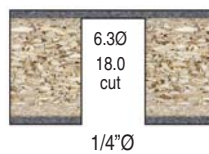

## GUIDED ROUND OVER

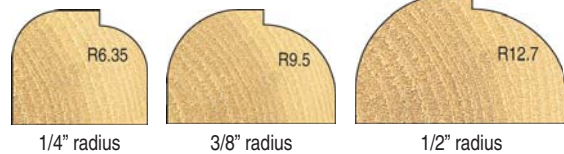

## GUIDED ROMAN OGEE

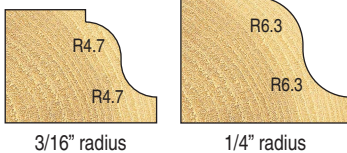

## GUIDED CLASSIC DECOR

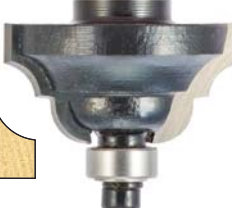
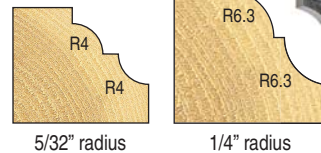

## WAVY EDGE

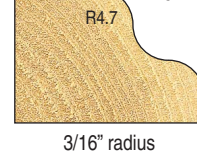

## 'V' GROOVE

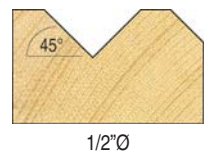

## CORE BOX

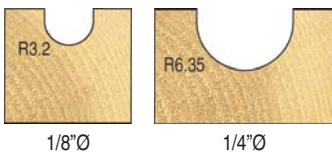

## LONG SERIES CORE BOX

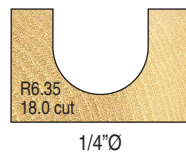

## GUIDED GROOVER

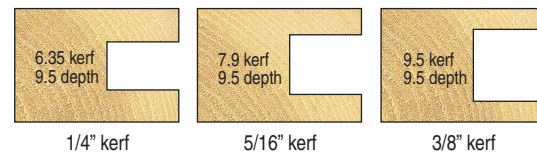

## GUIDED OVOLO

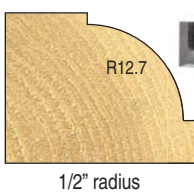

## GUIDED CAVETTO

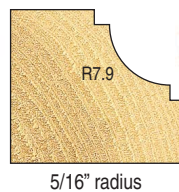

## DOVETAIL

