

12MM STACK SYSTEM

HEAVY DUTY ARBORS FOR 12MM BORE SLOTTERS

Heavy duty arbor with M12x1.0mm thread with spacers for 12mm bore slotters with or without bearings.

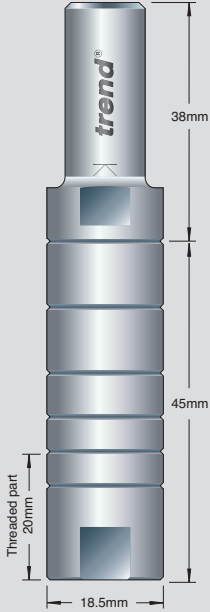

Product Ref. **33/1** Shank Diameter **1/2"** £27.79

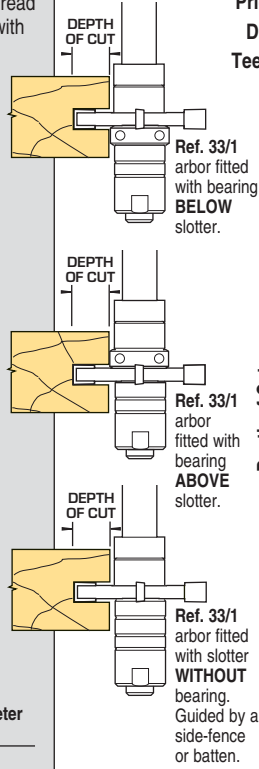

These slotters have a 12mm clear bore to enable them to be mounted at any position on the arbor in combination with spacers, with or without a bearing.

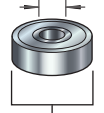

Kerf	2	2.5	4	5	6	6	8	10			
Ref.	39/6	39/9	34/1	34/04+	34/22	34/2	34/3	34/40			
Price	£74.21	£74.21	£63.24	£62.59	£51.29	£66.03	£72.24	£75.04			
Dia.	86 ▲	100 ▲	50	50	40	50	50	50	Ref.	Dia.	Price
Teeth	12	12	4	4	3	4	4	4			
	32.5	39.5	14.5	14.5	9.5	14.5	14.5	14.5	B210	21	£9.14
	30.5	37.5	12.5	12.5	7.5	12.5	12.5	12.5	B250	25	£14.96
	30	37	12	12	7	12	12	12	B26	26	£9.14
	29.5	36.5	11.5	11.5	6.5	11.5	11.5	11.5	B27	27	£14.96
	29	36	11	11	6	11	11	11	B28	28	£11.92
	28.5	35.5	10.5	10.5	5.5	10.5	10.5	10.5	B29	29	£14.96
	28	35	10	10	5	10	10	10	B30	30	£11.92
	27.5	34.5	9.5	9.5	4.5	9.5	9.5	9.5	B31	31	£14.96
	27	34	9	9	4	9	9	9	B32	32	£11.06
	26.5	33.5	8.5	8.5	3.5	8.5	8.5	8.5	B33	33	£14.96
	26	33	8	8	3	8	8	8	B34	34	£11.06
	25.5	32.5	7.5	7.5	2.5	7.5	7.5	7.5	B35	35	£11.06
	25	32	7	7	2	7	7	7	B36	36	£11.06
	24.5	31.5	6.5	6.5	1.5	6.5	6.5	6.5	B37	37	£6.62
	24	31	6	6	1	6	6	6	B38	38	£11.06
	23.5	30.5	5.5	5.5	0.5	5.5	5.5	5.5	B39	39	£13.91
	23	30	5	5	-	5	5	5	B40	40	£11.06
	22.5	29.5	4.5	4.5	-	4.5	4.5	4.5	B41	41	£16.03
	22	29	4	4	-	4	4	4	B42	42	£12.59
	21.5	28.5	3.5	3.5	-	3.5	3.5	3.5	B43	43	£12.59

M12 THREADED SYSTEM

HEAVY DUTY ARBORS FOR M12 BORE SLOTTERS

Slotlers with M12x1.0mm threaded bore enables flush recessing in the corner for weather proofing. Spacers are supplied where applicable to ensure the minimal threaded arbor protrudes below the slotter. Arbor Ref. 33/20 enables 12mm bore guide bearings to be fitted above slotter for self-guiding work.

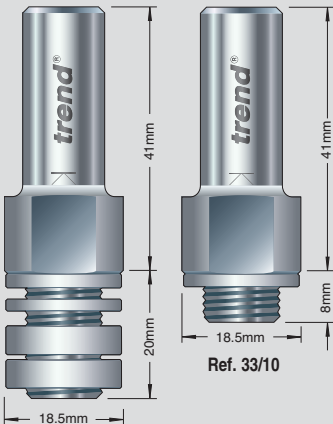

Product Ref. **33/10** Shank Dia. **1/2"** £16.00
33/20 £16.00
33/21 (for Ref. 34/16TC only) £16.00

These slotters have a M12 threaded boss to enable them to be threaded onto the arbor without the need for a securing nut.

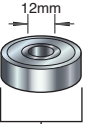
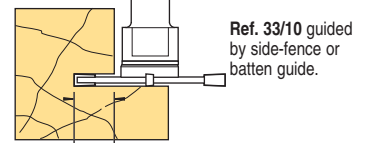
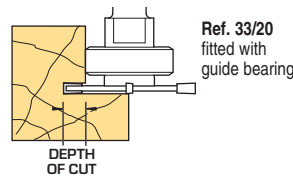

Kerf	2	2.5	3	4	5	6	7	8	9.5	10	11	15			
Ref.	34/03	34/9	34/10	34/11	34/110	34/12	34/7	34/13	34/5	34/15	34/14	34/16*			
Price	£68.82	£69.47	£69.47	£68.82	£70.93	£70.93	£77.15	£73.05	£86.93	£63.60	£79.26	£63.60			
Dia.	50	50	50	50	50	50	50	50	50	40	50	40	Ref.	Dia.	Price
Teeth	4	4	4	4	4	4	4	4	4	2	4	2			
	14.5	14.5	14.5	14.5	14.5	14.5	14.5	14.5	14.5	9.5	14.5	9.5	B210	21	£9.14
	12.5	12.5	12.5	12.5	12.5	12.5	12.5	12.5	12.5	7.5	12.5	7.5	B250	25	£14.96
	12	12	12	12	12	12	12	12	12	7	12	7	B26	26	£9.14
	11.5	11.5	11.5	11.5	11.5	11.5	11.5	11.5	11.5	6.5	11.5	6.5	B27	27	£14.96
	11	11	11	11	11	11	11	11	11	6	11	6	B28	28	£11.92
	10.5	10.5	10.5	10.5	10.5	10.5	10.5	10.5	10.5	5.5	10.5	5.5	B29	29	£14.96
	10	10	10	10	10	10	10	10	10	5	10	5	B30	30	£11.92
	9.5	9.5	9.5	9.5	9.5	9.5	9.5	9.5	9.5	4.5	9.5	4.5	B31	31	£14.96
	9	9	9	9	9	9	9	9	9	4	9	4	B32	32	£11.06
	8.5	8.5	8.5	8.5	8.5	8.5	8.5	8.5	8.5	3.5	8.5	3.5	B33	33	£14.96
	8	8	8	8	8	8	8	8	8	3	8	3	B34	34	£11.06
	7.5	7.5	7.5	7.5	7.5	7.5	7.5	7.5	7.5	2.5	7.5	2.5	B35	35	£11.06
	7	7	7	7	7	7	7	7	7	2	7	2	B36	36	£11.06
	6.5	6.5	6.5	6.5	6.5	6.5	6.5	6.5	6.5	1.5	6.5	1.5	B37	37	£6.62
	6	6	6	6	6	6	6	6	6	1	6	1	B38	38	£11.06
	5.5	5.5	5.5	5.5	5.5	5.5	5.5	5.5	5.5	0.5	5.5	0.5	B39	39	£13.91
	5	5	5	5	5	5	5	5	5	-	5	-	B40	40	£11.06
	4.5	4.5	4.5	4.5	4.5	4.5	4.5	4.5	4.5	-	4.5	-	B41	41	£16.03
	4	4	4	4	4	4	4	4	4	-	4	-	B42	42	£12.59
	3.5	3.5	3.5	3.5	3.5	3.5	3.5	3.5	3.5	-	3.5	-	B43	43	£12.59

* These groovers must be used with different arbors - see left.

Above Bearings for use with Ref. 33/20 Arbor.