



T11 Jig & Table Quick Fixing Kit T11/JT/KIT

Please read carefully before use



INST/T11/JTK v2.0

T11 QUICK RELEASE KIT REF. T11/JT/KIT

Thank you for purchasing this Trend product which should give lasting performance if use in accordance with these instructions.

The following symbols are used throughout these instructions.



Denotes risk of personal injury, loss of life or damage to the tool in case of non-observance of the instructions.



Refer to the instruction manual of your power tool.

This unit must not be put into service until it has been established that the power tool to be connected to this unit is in compliance with 98/37/EC (identified by the CE marking on the power tool).

INTENDED USE

This accessory is intended to be used with only a T11 plunge router and router tables such as the Trend PRT router table or as a retro-fit to other suitable accessories to allow the T11 router to be fitted and removed quickly.

SAFETY

Please read and understand the safety points at end of this instruction as well as the power tool instructions before use.



When using large panel raiser cutters, making deep cuts or if the router is to be used inverted for long periods, the T11 plunge router should also be secured to the table using the three shorter M6 machine screws into the TBC router fixing holes.

ITEMS REQUIRED

- T11 Router
- PRT Professional router table
- No. 3 Pozzi® screwdriver
- 10mm A/F spanner

Or as retro-fit

- T11 Router
- Router table or jig with minimum 8mm thick table top
- Measuring tools
- Drill and drill stand
- 6mm diameter through hole drill
- 13mm diameter countersink bit
- Drill bit or stepped drill bit for 20mm through hole
- No. 3 Pozzi® screwdriver
- 10mm A/F spanner

A 2.5mm hex key or nail/pin may be required to act as a tommy bar.

ITEMS ENCLOSED & DESCRIPTION OF PARTS

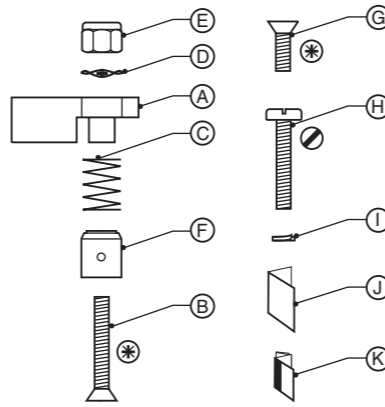

- A. Cam lever **x3**
- B. Cam lever fixing machine screw csk M6 x 40mm Pozzi® **x3**
- C. Spring **x3**
- D. Wavy washer **x3**
- E. Half nut M6 Nyloc® **x3**
- F. Steel bush with eccentric bore **x3**
- G. Router TBC fixing machine screw csk M6 x 20mm Pozzi® **x3**
- H. Alternative cam lever fixing machine screw pan M6 x 40mm slot **x3**
- I. Split washer M6 **x3**
- J. Hole position diagram **x1**
- K. Instructions **x1**

ASSEMBLY

Fitting Quick Release Kit to router tables

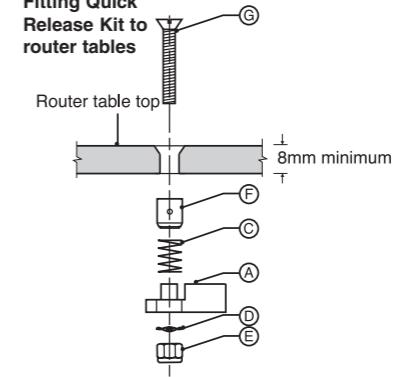

Isolate router from power supply before fitting the accessory kit.

The fixing kit uses three cam levers to lock the router into router tables such as the Trend PRT router table. The kit can be retro-fitted to certain tables including user made tables or jigs as long as the table surface is no less than 8mm thick and there is sufficient room to turn the cam levers fully. The table surface will need to be drilled with suitable size holes in a set pattern. The metal bushes are manufactured with the centre tapped hole

EC Design Application Applied For
© Trend Machinery & Cutting Tools Ltd. 2010 E&OE
© All trademarks acknowledged

Trend Machinery & Cutting Tools Ltd.
Odams Trading Estate St Albans Road
Watford WD24 7TR England
Tel: 0044(0)1923 249911
technical@trendm.co.uk
www.trend-uk.com



ASSEMBLY continued

drilled 0.5mm off centre. This will allow for some adjustment to ensure an accurate fit of the router within the bushes.



The table top surface being used should not be less than 8mm thick, and it should ideally be made from a metal or very hard plastic.

If the table surface is thicker than 8mm and the countersunk holes cannot be drilled deeper then longer machine screws will be need to be purchased.



Fitting Quick Release Fixing Kit to PRT table

- Isolate router from power source.
- Remove middle alloy extrusion plate from table.

Underside view

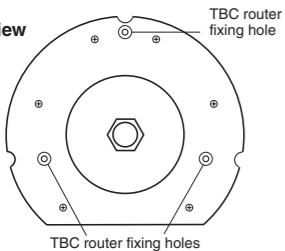

- Line up the TBC holes in the base of the T11 with the three countersunk holes in the plate.
- Secure the T11 using the M6 x 20mm countersunk machine screws included in

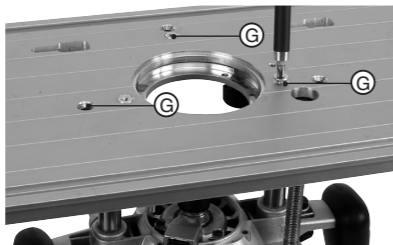

the kit (G). These screws are used to hold the router centrally whilst fitting and adjusting the cam assembly.

- Tighten the screws.

With the router still fitted to the middle plate: -

- Turn the middle plate over and place the



inverted plate back into the table so that the router is now mounted overhead, this allows easier access to fit the cam assembly.

- With the shoulder uppermost, place one of the bushes (F) into the recess in the outside edge of the base of the T11 (the c'sink in the base of the bush will be facing downwards towards the plate).

- From the underside of the centre plate place one M6 x 40mm countersunk machine screw (B) into the hole in the centre plate and thread on to the bush.

- Using a No. 3 Pozzi® screwdriver on the screw, thread the bush down the screw until it nearly touches the plate, now rotate the bush (which is eccentrically drilled) so that the edge of the bush touches the recess in the router base. You may need to turn screw as well to ensure bush seats correctly into the recess.

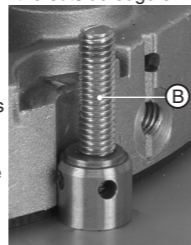
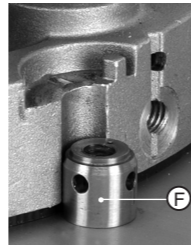

- Once in correct position, hold the bush with your fingers and tighten the screw with the screwdriver. A 2.5mm hex key or pin/nail (not supplied) may be required to be placed into one of the holes to stop the bush rotating. Do not use pliers to hold the bush.

- Repeat for the other two bush and cam lever fixing screw assemblies.

- Check the cam lever fixing screws to ensure they are tight.

- Assemble the spring (C) onto the machine screw and seat it over the recess on the end of the bush.

- Place the cam lever (A) with the spigot facing down on the screw; the cam lever will need to be in an open position. Ensure spigot of cam lever fits inside the spring.

- Fit wavy washer (D) and then M6 half Nyloc® nut (E) on to the machine screw. Using a 10mm A/F spanner (not supplied) tighten the M6 Nyloc® nut down until the cam shoulder is 20mm above plate surface.

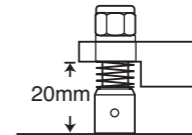

- Turn the cam so that the front section of the cam is above the front section of the T11 recess (in the part open position) and then tighten the nut until the cam shoulder rests onto the T11 recess.

- Then tighten nut a quarter turn clockwise.

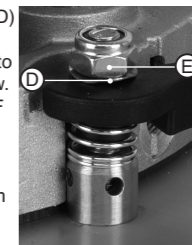

Do not over-tighten. Do not tighten down with the cam in the closed position.

- Repeat for the other two assemblies.
- Remove the router fixing screws (G) holding the router to the centre plate (TBC holes).
- Check the fit of the router in the three bush assemblies. The fit should be reasonably tight, but must allow for the router to be lifted up vertically. If the cam assembly is too tight, adjust cams by loosening the cam lever fixing screws and turning all the cams slightly anti-clockwise. An eighth of a turn is recommended.

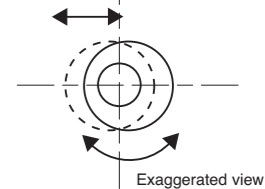

(continued)

To check the fit of the quick release assembly on T11.



■ Turn the cam levers clockwise so that they are in the locked position, the cam lever will go tight as it rides over the ridge in the recess, and the groove in the cam lever will engage the ridge and lock the cam lever. A stop in the base recess prevents the cam lever from turning further.

■ Check the fit for all the cam levers. If the fit is too loose or tight, adjust where necessary.

The quick release assembly is now ready for use. Turn the centre plate with the router fitted over and place the centre plate into the PRT centre aperture. Lock down plate using the turn buttons and refit table ring, back fence and guard assemblies where applicable. Plug the router into the no-volt release switch. The router table is now ready for use.

OPERATION



Isolate router from power supply before fitting router and removing router from table or jig.

With the quick release cam assembly fitted to the jig or table, the T11 router can be easily fitted and removed. To fit the router: -

■ Ensure the three cam levers are in the open position.

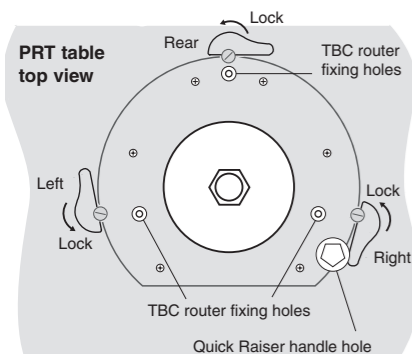

■ Place the T11 router into the middle of the three bushes and then firstly tighten the left and right hand cam levers clockwise. Lastly lock the rear cam lever clockwise.



To remove the router, isolate from power source and simply turn all three clam levers anti-clockwise (unlocked position) ensuring the cam levers are open before removing the router vertically.



■ Check all three cam levers are secure before use. The router table can then be used normally following the router table instructions.

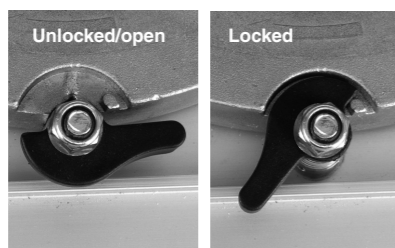

Ensure all three lever cams are locked properly onto T11 base before use.

To remove the T11 router: -

■ Isolate router from power source.

■ Whilst supporting the router, firstly unlock the rear cam lever by turning it anti-clockwise and then unlock the left and right cam levers (also anti-clockwise).

■ With the three cam levers in the open position remove the T11 router vertically.



Fitting Quick Release Kit To Other Router Tables or Jigs

See Hole Position Diagram (J).

It is recommended that the table or jig is drilled for the TBC holes as well as the quick release holes and Quick Raiser™ hole. The Quick Raiser™ hole will not need to be drilled if the router is being used in an overhead jig or overhead router stand mode. The TBC holes should be drilled first, either using the hole position diagram or by removing the phenolic slider base from the router and using it as a drill guide. The drawing will need to be accurately positioned.



The third apex TBC hole should be towards the rear, so that the front of the router when in the table, is facing forwards.

Underside view

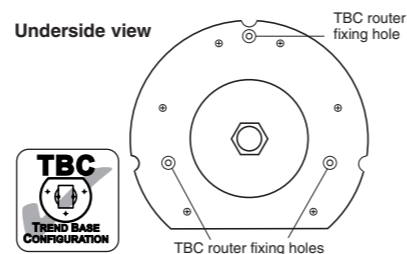

To mark hole positions:-

■ Draw centre cross lines onto the top surface of the router table top with a pencil. These lines should be approx. 250mm long.

■ With the hole position drawing in the correct orientation, align the lines on the drawing to the lines on the table. Use sticky tape to secure drawing. Double check dimensions before drilling.

■ Centre mark the centre of the holes. Using a pillar drill or drill stand drill a pilot hole in the centre. Increase hole size to 6.3mm diameter. Use a countersink tool to countersink the hole to a diameter of 13mm. This will allow for the countersunk screw head.

If drilling MDF use wood cutting tools, for metal use metal cutting tools with a coolant and wear gloves.

The 20mm through hole for the T11 Quick Raiser™ handle can be drilled from the top surface using a hole saw if the table is made from MDF or a stepped drill Ref. 38/6x3/8HSS at slow speed with a coolant if the table surface is metal. Centre mark the hole centre and using a drill stand or carefully with an electric drill, slowly drill the hole to 20mm diameter. If the material is metal the hole edge will need to be deburred.

Then follow the steps for fixing the T11 to the PRT as shown previously.

If you are not confident in drilling the three hole positions accurately then an alternative is to drill three oversize counter bored holes and use the three supplied pan head screws (H) with split washers (I). The counterbore hole allows for some adjustment. The counterbore size would need to be 16mm diameter by 6mm deep, with an 8mm through hole. Once all the holes have been drilled and counterbored then follow the steps for fixing the T11 to the PRT as shown previously.

Router table mode

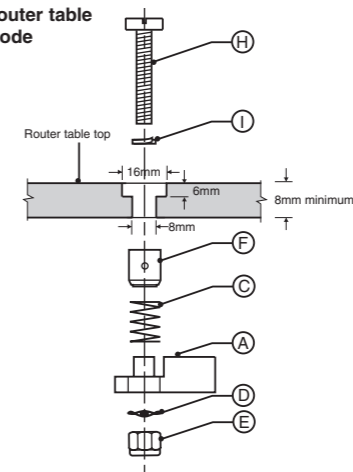

MAINTENANCE

The accessory has been designed to operate over a long period of time with minimum of maintenance. Continual satisfactory operation depends upon proper tool care and regular cleaning.

Check Damaged Parts

■ Regularly check cams to ensure they have not become worn or damaged. If they are worn or damaged do not use and replace.

Cleaning

■ Keep the threads and springs clear of sawdust and resin build up.
■ Regularly clean with a soft cloth.

Lubrication

■ Your accessory requires no additional lubrication.



When using large panel raiser cutters, making deep cuts or if the router is to be used inverted for long periods, the T11 plunge router should also be secured to the table using the three shorter M6 machine screws into the TBC router fixing holes.

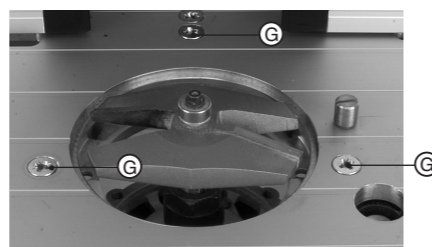

SPARE PARTS

Item	Qty.	Desc.	Ref. (1 off)
A	3	Cam Lever	WP-T11/J/T1
B	3	Machine Screw Csk M6 x 40mm Pozzi®	WP-SCW/19
C	3	Spring Compression 19mm x 11.5mm	WP-SPR/C/02
D	3	Wavy Washer 6.5mm x 11mm x 1mm	WP-WASH/13
E	3	Nut Hex Half Nyloc®, M6	WP-NUT/07
F	3	Bush Steel Eccentric M6 Bore	WP-T11/J/T2
G	3	Machine Screw Csk M6 x 20mm Pozzi®	WP-SCW/37
H	3	Machine Screw Pan M6 x 40mm Slot	WP-SCW/30
I	3	Washer Split M6	WP-WASH/30
J	1	Hole Position Diagram	DIAG/T11/JTK
K	1	Instructions	INST/T11/JTK

Safety Points

1. Disconnect power tool and attachment from power supply when not in use, before servicing, when making adjustments and when changing accessories such as cutters. Ensure switch is in "off" position and cutter has stopped rotating.
2. Read and understand instructions supplied with power tool, attachment and cutter.
3. Current Personal Protective Equipment (PPE) for eye, ear and respiratory protection must be worn. Keep hands, hair and clothes clear of the cutter.
4. Before each use check cutter is sharp and free from damage. Do not use if cutter is dull, broken or cracked or if any damage is noticeable or suspected.
5. The maximum speed (nmax) marked on tool or in instructions or on packaging shall not be exceeded. Where stated, the speed range should be adhered to.
6. Insert the shank into the router collet at least all the way to the marked line indicated on the shank. This ensures at least 3/4 of shank length is held in collet. Ensure clamping surfaces are clean.
7. Check all fixing and fastening nuts, bolts and screws on power tool, attachment and cutting tools are correctly assembled, tight and to correct torque setting before use.
8. Ensure all visors, guards and dust extraction is fitted.
9. The direction of routing must always be opposite to the cutter's direction of rotation.
10. Do not switch power tool on with the cutter touching the workpiece.
11. Trial cuts should be made in waste material before starting any project.
12. Repair of tools is only allowed according to tool manufacturers instructions.
13. Do not take deep cuts in one pass, take shallow passes to reduce the side load applied to the cutter.

Please see www.trend-uk.com/safety for more safety advice.



Our policy of continuous improvements mean that specifications may change without notice. Trend Machinery & Cutting Tools Ltd. cannot be held liable for any material rendered unusable, or for any form of consequential loss.