

NEW PRODUCTS

ADDITIONS TO 2011/12 CATALOGUE **OCT 2012**

NEW



ROUTER CUTTERS

NEW



FOLDING FLUSH SAW

NEW



SELF-ADHESIVE NON-SLIP MAT

NEW



CRAFTPRO SHARPENING

NEW



COMBINATION ROUTER BASE



NEW
DOOR LIFTER

INCLUDES
SPECIAL OFFERS

PRICES
VALID UNTIL
28TH FEB 2013

trend[®]
routing technology

NEW 2012

COMBINATION ROUTER BASE

A quick change, multi-functional router base. Fits most routers with 8mm, 10mm and 12mm diameter rods at 78mm to 130mm centres.

- Quick Fit Base
- Multi-functional
- Improved Accuracy
- Greater Stability
- Superior Finish
- Saves Time

7 FUNCTIONS

MULTI-FUNCTIONAL

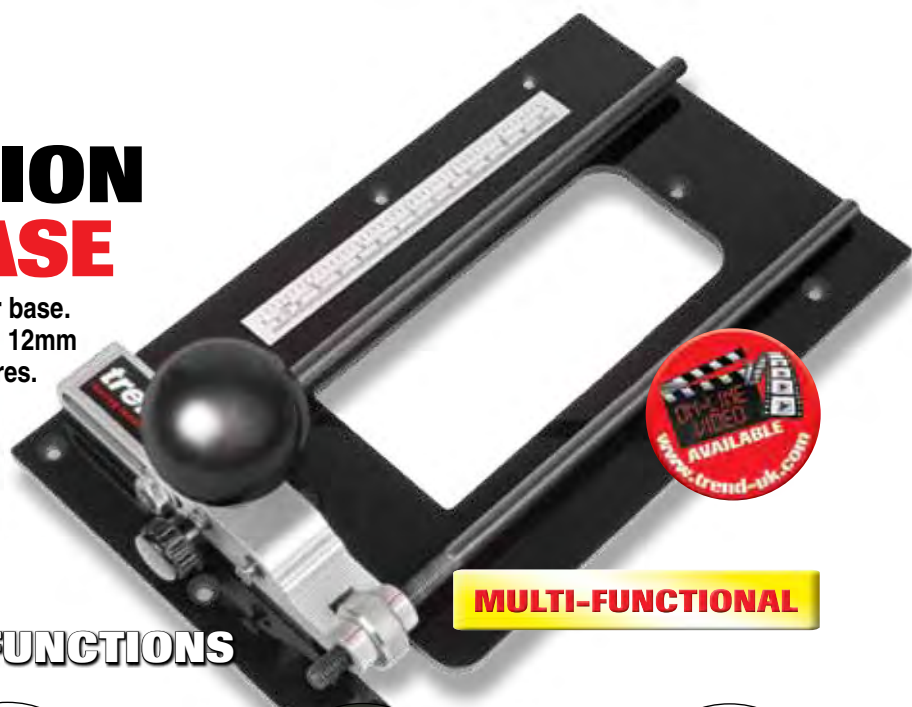

1
Offset Base
For better control when edge routing.



2
Router Compass
For routing circles of 19mm to 224mm radius.



3
Clamp Guide Adjustable Grooving
With 40mm micro adjustment.



4
Anti-tilt Support
For stable edge work. Height range 8mm to 80mm.



5
Offset Mortising
For timber thickness 50mm to 200mm.



6
False Panel Groove Copier
For creating repeated grooves.



7
Varijig Frame System
Anti-tilt facility for panel cutting when used with the Varijig with accessory guide bush ref. GB40/B (see page 12).

Product Ref. **CRB** £69.00

ACCESSORIES

SIDE FENCE

Made from 15mm thick clear acrylic. Screws onto Combination Router Base. 270mm long. Facility to accept false fence.

NEW OCT 2012



Product Ref. **CRB/SF** £14.90

CRANKED RODS

Pair of 7mm diameter rods to allow more precise levelling of bridge when using different routers and to allow for smaller rod centre routers of 60.3mm to 174mm.

NEW OCT 2012



Product Ref. **CRB/CR** £17.00

+4 MORE FUNCTIONS WITH ACCESSORIES

TRIMMING BASE

Trim Base with bearing guide follower for flush edge trimming of hardwood lippings.

NEW



Product Ref. **CRB/TB** £24.00

EXTENSION RODS

Two pairs of rods for increasing circle radius by 560mm.

NEW



Product Ref. **N/COMPASS/AEX** £19.32

Router, cutter, clamp guide and jig accessories not included.

NEW 2012

CRAFTPRO DIAMOND SHARPENING

Our new range of diamond sharpening products for sharpening, deburring or honing a wide range of tools.

- Monocrystalline diamond for fast, clean stock removal.
- Double-sided for coarse sharpening and fine honing.
- Fast, easy to use, durable and versatile.
- Trend Lapping Fluid recommended.
- Fine grade used for cabinet making and carving tools. Fine finish refines the cutting edges of all hand tools, spindle knives, chisels and plane irons. Achieves a razor sharp edge in seconds.
- Coarse grade for carpentry and joinery, rapidly fixes or restores damaged or blunt tools.



CREDIT CARD STONE

A double-sided credit card size diamond stone.

- For router cutters, turning tools etc.
- Excellent sharpening performance.
- Monocrystalline diamonds for fast, clean, stock removal.
- Double-sided for coarse sharpening and fine honing.
- Use with lapping fluid.
- Size: 82mm x 50mm x 0.8mm.



Product Ref.	Grade	Grit	Micron
CR/DWS/CC/FC _ £9.90	◆ Fine	600	25
	◆ Coarse	360	40

4" DOUBLE-SIDED STONE WITH FOLDING HANDLE

A folding handle double-sided diamond 4 inch stone.

- Folding ABS plastic handle to protect diamond surface.
- For sawblades, chisels & knives.
- Oval hole design to collect and hold metal filings.
- Use with lapping fluid.
- Size: 89mm x 20mm x 6mm.



Product Ref.	Grade	Grit	Micron
CR/DWS/F4/FC _ £14.90	◆ Fine	600	25
	◆ Coarse	360	40

BENCH STONE 6" X 2-3/8"

A double-sided diamond bench stone in plastic case.

- For plane irons and chisels.
- Plastic base with non-slip feed and cover.
- Fine side has oval hole design to collect and hold metal filings with clear diamond area for small tools.
- Solid diamond on coarse side.
- Use with lapping fluid.
- Size: 152mm x 61mm x 6mm.



Grade	Grit	Micron
◆ Fine	600	25
◆ Coarse	360	40

Product Ref.
CR/DWS/B6/FC _ £29.90



NEW PROFESSIONAL ROUTER CUTTERS

BEARING GUIDED BEVEL TRIMMERS

NEW 2012

Tungsten Carbide tipped laminate trimmers. **TCT**

- Two fluted for clean finish.
- Bearing guided for straight or shaped work.
- Cuts a wider edge line. Two angles available 75° (15° from vertical) or 65° (25° from vertical).



Product Ref.

46/6EX1/4TC £19.90
(75° x 15.9mm dia x 6.3mm cut)

46/6FX1/4TC £19.90
(65° x 19.1mm dia x 6.3mm cut)

FOUR FLUTE 90° DOUBLE BEARING GUIDE TRIMMERS

NEW 2012

Four fluted tool with bearing guide on shank and nose. **TCT**

- Four fluted for super fine finish.
- Top and bottom bearing allows template to be either on top or bottom.
- Ideal for irregular grained timber to make profiling easier by turning component other way up.

FOUR FLUTE



Product Ref.

46/501X1/2TC £69.00
(19.1mm dia x 50mm cut)

45 DEGREE 'V' GROOVE ROUTER CUTTERS

Tungsten Carbide tipped for 'V' grooving and edge chamfering.

- Two fluted for clean finish.
- Ideal for panelling.
- Can be used for engraving and sign writing.

FOUR NEW SIZES



Product Ref.

11/2X1/2TC £27.30
(9.5mm dia. x 5mm cut)

11/31X1/4TC £21.00
(12.7mm dia. x 6.55mm cut)

11/31X1/2TC £21.00
(12.7mm dia. x 6.55mm cut)

11/32X1/4TC £22.50
(16mm dia. x 8mm cut)

11/32X1/2TC £22.50
(16mm dia. x 8mm cut)

11/30X1/2TC £45.00
(25.4mm dia. x 13mm cut)



LINEN FOLD ROUTER CUTTERS

NEW

Cutters to create linen fold effect on panels.



- Two fluted for clean finish on timbers.
- Linen fold cutter Ref. 18/96 creates mould for panel and the guided dish cutter Ref. 23/12 creates the scroll effect to finish the linen fold ends.
- A user-made template is required.
- Full instructions included. **TCT**



Ref. 18/96

Ref. 23/12
For scroll effect

Product Ref.

18/96X1/2TC £74.00
Linen fold (25mm dia x 44mm cut)

23/12X1/4TC £39.50
Scroll (R4mm x 12.7mm dia)

TEMPLATE OVERSIZE ROUTER CUTTER

TCT

For Porter-Cable® Latch & Strike Template (59375) and Hinge Template (59370).

- Useful when making jigs, templates and patterns.
- Shank mounted bearing guided.
- Down shear for clean cut.
- Equivalent to Porter-Cable® Ref. 43671.
- 12.7mm diameter x 9.5mm cut with 15.9mm diameter bearing.

NEW



Product Ref.

26/4X1/4TC £25.00
(12.7mm dia x 9.5mm cut)

TWO FLUTE STRAIGHT ROUTER CUTTER

NEW

Two flute Tungsten Carbide tipped cutter for timbers and man-made boards.

- For routing grooves and rebates.

TCT



Product Ref.

3/52X1/2TC £21.50
(9mm dia x 25mm cut)

NEW STRAIGHTS

NEW
SEPT 2012



TCT
TUNGSTEN
CARBIDE
TIPPED

TWO FLUTE STRAIGHTS

Tungsten Carbide tipped cutters for timbers and man-made boards.

- Two flutes for a clean finish.
- For routing grooves and rebates.
- Cutters over 9.5mm have Tungsten Carbide centre tip for plunge cutting.
- Metric diameters.
- Ref. 3/73DM has an 84mm overall length with or short shank and is ideal for Makita, Ryobi and Hitachi routers.

8 NEW STRAIGHTS

Product Ref.	
3/24X1/4TC	£21.00
3/24X1/2TC	£30.35
(6mm dia. x 25mm cut)	
3/73DMX1/2TC	£34.23
(12mm dia. x 50mm cut, short shank)	
4/05X1/4TC	£25.94
(14mm dia. x 20mm cut)	
4/27X1/2TC	£34.76
(16mm dia. x 25mm cut)	
4/28X1/2TC	£32.55
(16mm dia. x 35mm cut)	
4/63X1/4TC	£35.91
(20mm dia. x 20mm cut)	
4/66X1/2TC	£30.55
(22mm dia. x 25mm cut)	



3 PIECE KITCHEN FITTERS PACK

NEW

Tungsten Carbide Tipped cutters for routing the worktop joint with a jig and for creating biscuit joint slot.

- Two worktop cutters 12.7mm diameter x 50mm cut length with TC centre tip Ref. TR17D X1/2TC.
- One piece 4mm kerf bearing guided biscuit jointing cutter Ref. TR35X1/2TC for biscuit sizes No. 0, 10 and 20.
- Biscuit cutter is used to reinforce worktop joint using biscuits (not included).

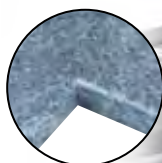

3 PIECE SET



TCT
TUNGSTEN
CARBIDE
TIPPED

Product Ref. **TR/KFP/5** **£69.00**

NEW
SEPT 2012

CRAFTPRO ROUTER CUTTERS

WEATHERSEAL GROOVE CUTTERS

TCT

PTFE non-stick coated bearing guided cutters to create grooves for weatherseal using a smaller router where application allows.

- Two fluted for clean finish.
- Groove widths 2mm, 2.5mm, 2.7mm and 3mm.
- Groove can be positioned in bottom of a rebate.
- Bearing guided to give 7mm deep groove.
- Other bearings available for other groove depths.
- 34mm diameter.



NEW

PILE CARRIER ROUTER CUTTERS

TCT

PTFE non-stick coated bearing guided cutters to create a groove for pile carriers using a smaller router where application allows.

- Two fluted for clean finish.
- Three types available to suit centre leg, offset or plain pile carrier.
- Bearing guided.
- Ideal for parting bead.



NEW

NEW

NEW

Product Ref.

C210AX1/4TC	£34.76
(2.0mm kerf x 7mm deep)	
C211AX1/4TC	£34.76
(2.5mm kerf x 7mm deep)	
C212AX1/4TC	£34.76
(2.8mm kerf x 7mm deep)	
C213AX1/4TC	£34.76
(3.0mm kerf x 7mm deep)	

Accessory Bearings

BB24	£8.82
(24mmØ for 5mm groove depth)	
BB22	£8.82
(22mmØ for 6mm groove depth)	
BB19	£8.82
(19mmØ for 7.5mm groove depth)	
BB18	£8.82
(16mmØ for 8mm groove depth)	
Spare Bearing	
BB20	£8.82
(20mmØ for 7mm groove depth)	

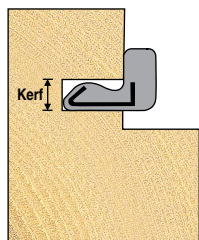

Product Ref.

C224X1/4TC	£39.90
(Offset leg pile carrier)	
C225X1/4TC	£29.00
(Centre leg pile carrier)	
C225CX1/4TC	£29.00
(Plain pile carrier)	

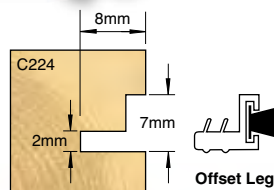

Offset Leg

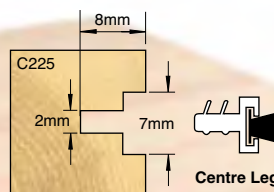

Centre Leg

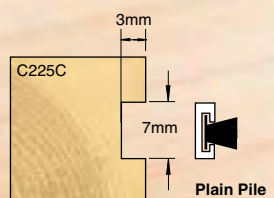

Plain Pile

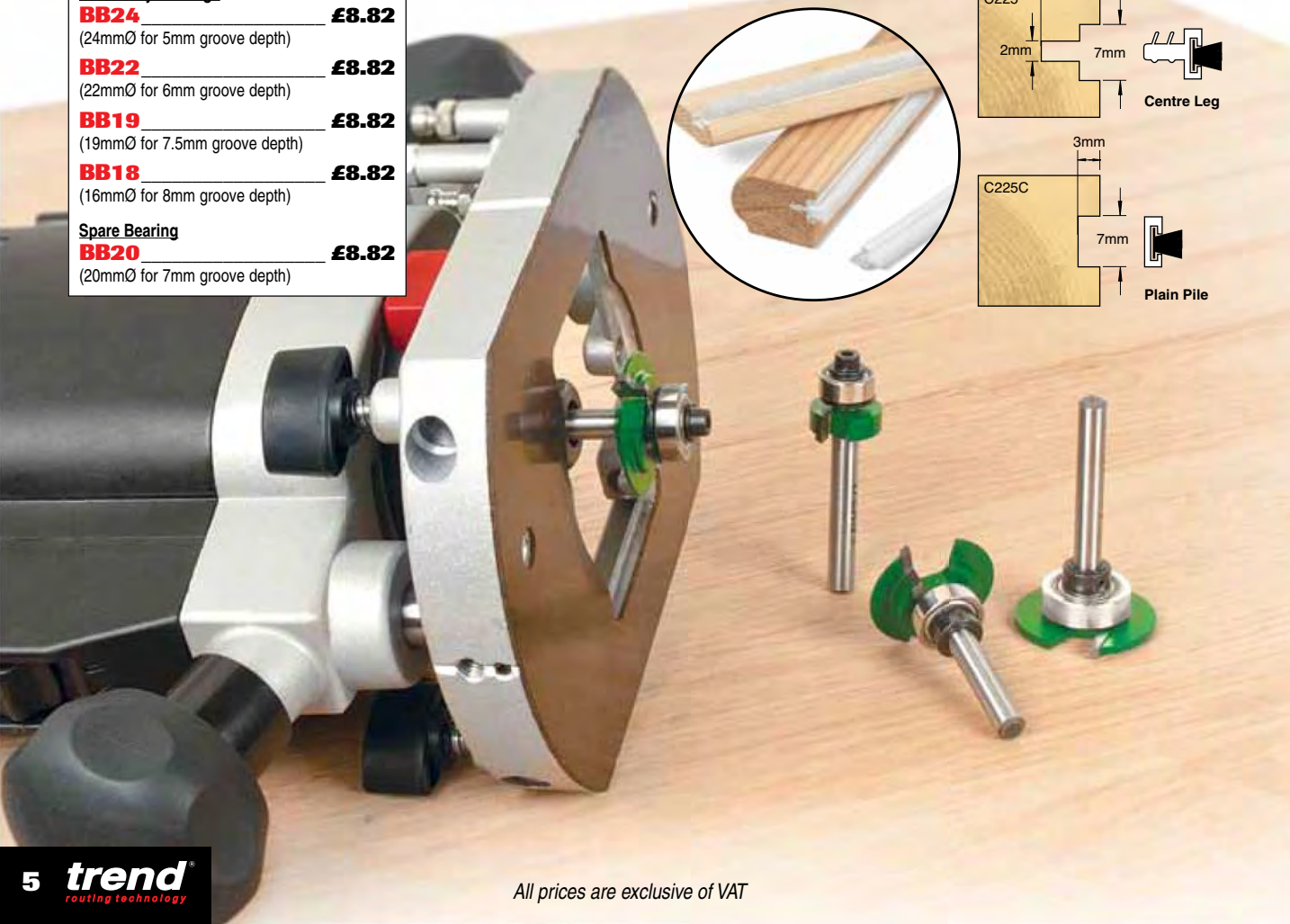

NEW CRAFTPRO SAWBLADES



Designed for a professional finish in wood, MDF, particle board, hardboard and plywood.

- Microgranular Tungsten Carbide Tipped to allow cutting of abrasive materials.
- Sawblades for portable saw including plunge saws and mitre saws.

IDEAL FOR PLUNGE SAWS

Dewalt DWS520K
Festool TS55EQ
Mafell MT55CC
Makita SP6000K

IDEAL FOR CORDLESS TRIM SAWS

AEG BKS18i

IDEAL FOR MITRE SAWS

Dewalt DW700
Elu PS174



TCT
TUNGSTEN
CARBIDE
TIPPED

14 NEW SIZES



CRAFTPRO
sawblades

TUNGSTEN CARBIDE TIPPED



PROTECTION
MUST BE WORN



16mm

∅ = 184mm

∠ = 30

MAX = 9500
RPM

DIA.	TEETH	KERF	THICK	BORE	TYPE	HOOK	APPLICATION	FOR MACHINE	PRODUCT REF	PRICE
160	48	2.2	1.6	20	TCP	plus 4°	Trimming of panels*	Festool TS55EQ plunge saw	CSB/PT16048	£ 39.00
160	52	2.2	1.6	20	TCP	neg. 6°	Aluminium and plastic	Festool TS55EQ plunge saw	CSB/AP16052	£ 39.00
160	48	2.2	1.6	20	ATB	plus 15°	Along and across grain	Festool TS55EQ plunge saw	CSB/16048A	£ 23.70
160	28	2.2	1.6	20	ATB	plus 15°	Along and across grain	Festool TS55EQ plunge saw	CSB/16028A	£ 21.00
162	48	1.8	1.2	20	ATB	plus 4°	Along and across grain	Mafell MT55CC plunge saw	CSB/16248	£ 21.00
165	24	1.6	1.0	15.88	ATB	plus 15°	Along and across grain	AEG BKS18Li cordless saw	CSB/16524TC	£ 20.50
165	48	1.6	1.0	15.88	ATB	plus 15°	Along and across grain	AEG BKS18Li cordless saw	CSB/16548TC	£ 21.00
165	64	1.6	1.0	15.88	ATB	plus 15°	Along and across grain	AEG BKS18Li cordless saw	CSB/16564TC	£ 23.00
165	48	2.2	1.6	20	ATB	plus 15°	Along and across grain	Makita SP-6000K plunge saw	CSB/16548B	£ 22.50
165	48	2	1.8	20	TCP	neg. 6°	Aluminium and plastic	Dewalt DWS520K plunge saw	CSB/AP16548	£ 29.00
165	48	2	1.8	20	TCP	plus 4°	Trimming of panels*	Dewalt DWS520K plunge saw	CSB/PT16548	£ 39.00
216	24	2.6	1.7	30	ATB	neg. 5°	Crosscut	Dewalt DW700, Elu PS174 mitre saw	CSB/CC21624	£ 25.80
216	60	2.6	1.7	30	ATB	neg. 5°	Crosscut	Dewalt DW700, Elu PS174 mitre saw	CSB/CC21660	£ 31.50
216	64	2.8	1.9	30	TCP	neg. 6°	Crosscut alloy/plastic	Dewalt DW700, Elu PS174 mitre saw	CSB/AP21664	£ 41.50

* Laminate faceside down.

VARIJIG CLAMP GUI

VARIJIG CLAMP GUIDES

Self clamping, straight line clamp guides that use the Varijig low profile extrusion.

- For accurate guiding of routers, saws and jigsaws.
- Low profile extrusion with integral clamping of work-piece, double locking mechanism and two full length T-slots.
- Common Varijig extrusion to 24 inch (610mm), 36 inch (915mm) and 50 inch (1270mm) Clamp Guides.
- Metric and imperial sliding scale.
- Extrusion profile 16mm high x 54mm wide.
- Ref. VJS/CG/PRO8 is an extra wide clamp 5" (127mm) with four T slots. Ideal for large sheet material. Clamps up to 2.44 metre.
- Jaws have fixing holes for accessories.

NEW

8 FOOT AVAILABLE

Product Ref.

VJS/CG/24 (24 inch / 610mm)	£27.00
VJS/CG/36 (36 inch / 915mm)	£32.00
VJS/CG/50 (50 inch / 1270mm)	£37.00
VJS/CG/PRO8 (8 foot / 96 inch / 2440mm)	£119.00

Router and cutter not included.

ACCESSORIES

A range of accessories for use with our Varijig Clamp Guides.

ROUTER BASE PLATE

Plunge router base accessory.

- Base plate engages in the T-slot in the extrusion.
- Made from clear plastic.
- Includes adjustable guide bar for perfect tracking using hex key provided.

NEW 2012

Product Ref.

VJS/CG/RBP **£19.00**

END STOP BLOCK

NEW 2012

Adjustable end stop block.

- Engages in the T-slot on the clamp guide extrusion and can be locked in position using locking knob.

Product Ref.

VJS/CG/ESB **£9.00**

SAW BASE PLATE

NEW 2012

Circular saw base accessory.

- Base plate engages in the T-slot in the extrusion.
- Includes adjustable guide bar for perfect tracking using hex key provided.

Product Ref.

VJS/CG/SBP **£19.00**

HANDLE EXTENSION

Lever extension handle for Varijig clamp guides.

- Gives better leverage to operate the clamp, especially when more clamping pressure is required.
- Increases lever length by 134mm.
- Can be fitted and removed quickly.

NEW 2012

Product Ref.

VJS/CG/EXT **£5.50**

DES & ACCESSORIES

SQUARING ATTACHMENT

Allows varijig clamp guide to be squared up for maximum accuracy.

NEW 2012

- Large 90° head allows clamp to be used as a clamping T-square.
- Serrated front edge.
- Includes fixing screws.



Product Ref.

VJS/CG/SQA £9.50

WIDE JAW KIT

NEW 2012

Pair of plastic jaws for fitting onto the jaws of the Varijig clamp guides.

- Distributes clamping pressure over the workpiece to minimise clamping marks.
- Built-in mounting holes allow a batten to be fitted.
- Includes fixing screws.



Product Ref.

VJS/CG/WJK £6.50

SIDE-TO-SIDE CLIPS

Allows two clamp guides to join side-to-side to clamp workpiece to workbench, obstruction free.

NEW MAY 2012

- Clamp one guide to the bench and attach another clamp upside down.
- Two clamps joined together creates a 112mm wide component support surface which is ideal for sanding.
- Six adapters are included so three pairs of clamps can be linked securely together.



6 CLIPS

Product Ref.

VJS/CG/SSC £13.00

For Varijig Clamp Guides only. Router and guides not included.

ADJUSTABLE SETTING GUIDE & STOP

A short alloy extrusion rail that can be fixed anywhere along the length of the Varijig clamp guide, so it limits the rail travel in a set position from an edge.



NEW MAY 2012

- Ideal for repetitive grooves.
- Removable alloy adjustable bridge guide stop can be locked in place.
- Bridge travel is 176mm.
- Can be used as a length stop.



Product Ref.

VJS/CG/AGS £13.00

FEATHER BOARD

Feather board finger pressure accessory.

- Clamps to the Varijig clamp guide which can then be easily clamped to a router table top.
- Provides horizontal side pressure.
- Includes fixing kit.



NEW MAY 2012



Product Ref.

VJS/CG/FB £9.50

BACK-TO-BACK CLIPS

Allows two Varijig clamp guides to be joined back to back.

NEW MAY 2012

- Clips comprise of alloy brackets and knobs.
- Raises component up 32mm for unobtrusive clamping especially for full edge mould work.



8 CLIPS

Product Ref.

VJS/CG/BBC £10.00



OTHER PRODUCTS IN THE VARIJIG RANGE

VARIJIG FRAME SYSTEM

Adjustable frame and guide for use with a router.

VARIJIG

cat page 158

VARIJIG STRAIGHT GUIDES

For routers, jigsaws and circular saws.

VJS/G/100 (100") cat page 158
VJS/G/35 (35") cat page 159

VARIJIG TENON & GROOVING

Allows grooves and tenons to be cut using a router.

VJS/TG/JIG

cat page 159

VARIJIG ANGLE GUIDE

Variable angle guide for the router or saw.

VJS/AG/36

cat page 160

DIGITAL DEPTH GAUGE

LCD depth gauge for setting tool height in a plunge router, router table and saw bench.

- Opening width 60mm and with 80mm measuring range.
- Metric, imperial and fraction read-out with auto shut off.
- Removable pin for hole depth measuring up to 50.8mm.
- Readout accuracy of +/- 0.1mm.
- Self standing with magnetic feet.
- Includes 3 volt CR2032 battery.

NEW



METRIC & IMPERIAL



Hole Depth



Horizontal Depth

Product Ref.

GAUGE/D60 £19.00

Spare Part

BAT/CR2032/3V £2.00

SAFETY GOGGLES

Superior quality ski style contoured safety goggles.

CONTOURED DESIGN

NEW

- Adjustable elastic head strap.
- Ventilation holes and all round eye protection.
- Soft comfortable facial contour.
- Indirect vents.
- Approved to EN166:2001 for high speed particles – medium and liquid splash.



CE



Ideal for use when routing



Suitable for use over most spectacles

Product Ref.

SAFE/GOG/B £8.50

NEW LIMITED EDITION

CRAFTPRO WORKTOP JIG

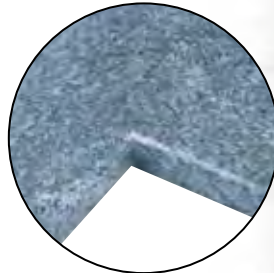

New worktop jig for use with 1/2" collet routers.

- Allows precise butt and scribe joints in worktops.
- Quick and easy to use.
- Fixed stop positions of 400mm, 500mm, 600mm, 616mm, 650mm, 700mm and 900mm.
- 12mm thick durable phenolic plastic.
- Alloy location bushes and engraved bush holes for easy identification.

FREE CUTTER
Includes a TCT Worktop Cutter



900MM WORKTOP JIG

- Fixed stop positions of 400mm, 500mm, 600mm, 616mm, 650mm, 700mm and 900mm.
- 22.5° mitre corner joint.
- Three types of peninsular cuts including 45° end cut, corner radius and curved peninsular.



Product Ref.

CR/KWJ900 £129.00

Router and guide bush not included.

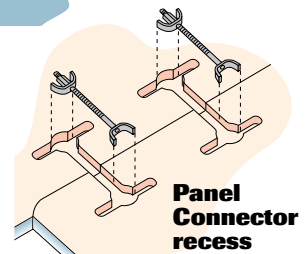
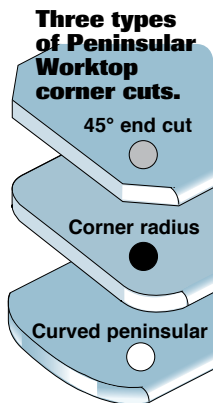
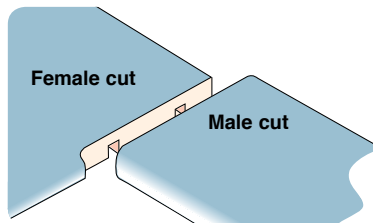
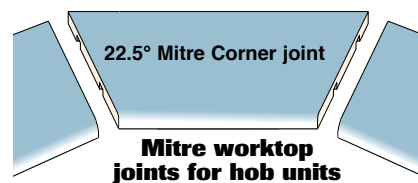

DOOR LIFTER

A foot operated door lifter to aid hanging doors.

- Slides under door and stays flat and stable until ready to activate the lift with users foot.
- Cam design with internal weight to keep level for ease of use.
- Ideal for pinned hinges.
- Lifts door 38mm (1-1/2") high and maximum weight 108 kg.
- Hanging hole for storage.



**NEW
NOV 2012**

Product Ref. **D/LIFT/A** £14.90



CRAFTPRO 82MM SOLID CARBIDE PLANER BLADES

Pair of solid Carbide blades for 82mm wide power planers.

- Size: 82mm x 5.5mm x 1.1mm.
- High grade carbide and precision ground.
- Two cutting edges and reversible for twice the life.
- Conversion kit required for Ref. CR/PB29 to fit some planers.

**NEW
SEPT 2012**



**STC
SOLID
TUNGSTEN
CARBIDE**



PLANER BLADE CR/PB29 TO SUIT:

Make	Model Refs.
AEG	(ATLAS COPCO) EH82, EH82.1, EH700, EH822, H750, H500, EH3-82, EH800, EH450
BLACK & DECKER	BD710, DN710, DN720, BD711, KW712, KW713, KW725, BD713, BD725
BOSCH	PHO2-82, PHO3-82/B, PHO15-82, PHO16-82, PHO25-82, PHO30-82, PHO100, PHO150, PHO200, PH300, 1592-9, GHO282, GH31-82, GHO36-82C
CASALS	CE82, CE98ACE
DEWALT	DW677, DW678K, DW678EK, DW680, D26500, D26501
DRAPER	PT682, P882
FELISATTI	TP282
FERM	FB82
FREUD	FE82, FE82VCE
HAFFNER	FH224
HITACHI	F20, FU20, P20V, P20SA
HOLZ-HER	2321, 2321-S, 2322, 2223 (NEW)
MAFELL	EHU82, MHU82, MHU82S, MHU82D
MAKITA	M102, 1900, 1900B, 1901, 1125, 1100, 1923B, 1923BD, 1923H, 1902, FB0800
METABO	EXPERT, 4382, HO0882, HO8382
NUTOOL	NPT82
PERLES	SK82A
PEUGEOT	RA82CS, RA400, RA3/82
SKIL	92H, 94H, 95H, 96H, 97H
RYOBI	L282, L1323A, HL-82, L-1835, L180, GH014, EPN-7582
WOLF/KANGO	8614, 8057, 8108

Model Refs. in bold indicate these planers need PB/CK119 Conversion Kit

Product Ref. **CR/PB29** £6.90

PROFESSIONAL SOLID CARBIDE PLANER BLADES

Trend Solid Carbide Planer Blades fit most makes of portable electric planers & are supplied in pairs.

- High grade carbide and precision ground.
- Two cutting edges and reversible for extended life.
- Conversion kit required for Ref. PB/29 to fit some planers.
- See Routing Catalogue page 113 for full compatibility.

**NEW
PRICES**



**STC
SOLID
TUNGSTEN
CARBIDE**



Product Ref.		
PB/22 (80.0 x 5.0 x 1.2mm)	_____	£9.95
PB/25 (80.5 x 5.9 x 1.2mm)	_____	£9.95
PB/27 (92.0 x 5.5 x 1.2mm)	_____	£11.60
PB/28 (75.5 x 5.5 x 1.1mm)	_____	£9.95
PB/29 (82.0 x 5.5 x 1.1mm)	_____	£9.95
PB/CK/119 (Conversion Kit for PB/29)	_____	£11.03

NOW WITH NAMIC CARBIDE FOR EXTRA LONG LIFE

All prices are exclusive of VAT

SELF-ADHESIVE BACKED NON-SLIP MAT

Ideal for gripping and holding component whilst woodworking.

NEW
OCT 2012

- Use for jig making.
- Can be used to refurbish pushblocks or lining the drawers of workshop tool chests etc.
- 300mm (12") x 300mm (12").
- Can be cut to size to suit application.

**SELF-ADHESIVE
BACKED**



Product Ref.

NS/MAT/B £6.90

PULLCUT 120MM FOLDING FLUSH SAW

Pullcut for trimming dowels, plugs and wooden nails.

NEW
MAY 2012

- Minimise damage to wood surface.
- Flexible thin blade.
- Non-set teeth.
- Soft touch handle that folds to protect blade.
- 22 TPI (1.15mm pitch) for fine finish.
- 120mm high carbon steel blade.



Product Ref.

FFS/120 £19.90

OTHER PRODUCTS IN THE CLAMPING RANGE

LOC BLOCKS

Pack of 4 interlocking gripping blocks, to hold workpiece in place, whilst sanding, drilling and routing.



LOC/BLK/PK1 cat page 189

NON-SLIP MAT

Specially formulated PVC gripping mat which holds workpiece in place.

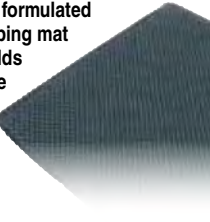

NS/MAT/A cat page 189

BAR CLAMP & SPREADER

One handed use clamps, available in 4 different sizes.



BCS/6 6" (152mm) cat page 187
BCS/12 12" (305mm) cat page 187
BCS/24 24" (610mm) cat page 187
BCS/36 36" (915mm) cat page 187

HEAVY DUTY GRIPPER CLAMP

F style quick action gripper clamps available in 3 different sizes.

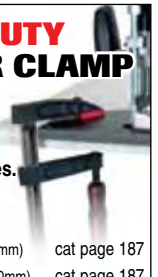

FC/200 8" (200mm) cat page 187
FC/300 12" (300mm) cat page 187
FC/500 20" (500mm) cat page 187

HEAVY DUTY DOUBLE-SIDED TAPE 25MM x 25 METRE

Rayon cloth coated double-sided tape for temporary fixing.

- Ideal for jig making.
- Rayon cloth coated with rubber resin adhesive for a strong hold.
- Siliconised paper release liner.
- Cut with a knife or scissors. Can be removed with your thumb.
- 25 metre x 25mm width x 0.25mm thick.

NEW 2012



Product Ref.

DS/TAPE/A _____ **£11.00**

EURO STYLE GUIDE BUSHES

- Metal guide bushes.
- Three new sizes.
- 24mm Ø x 10mm spigot for Varijig.
- 40mm Ø x 14mm spigot for Varijig Frame System for false panels. Accepts panel cutters up to 32mm diameter.
- 24mm Ø x 10mm spigot with thin wall for use with Trend Hinge Jigs for rounded hinges with 10mm radius corners. Use with 20mm Ø router cutters.

NEW 2012



NEW SEPT 2012



Product Ref.

GB24/A (24mmØ x10mm) _____ **£13.00**

GB240 (24mmØ x10mm thin wall) _____ **£13.00**

GB40/B (40mmØ x14mm) _____ **£13.00**

RYOBI ERT2100 1/2" COLLET

Replacement collet for Ryobi ERT2100 router.

- 1/2" (12.7mm) collet.
- Fits Ryobi ERT2100 router.
- We offer a full range of collets for various makes and models. Please see our website or catalogue for more details.

NEW SEPT 2012



Product Ref.

R2100/127 _____ **£6.50**

MINI HEX KEY SET

16 mini hex keys for router cutter use.

16 PIECE

- Chrome-vanadium.
- Metric and imperial hex keys.
- Metric sizes 0.7mm, 0.9mm, 1.3mm, 1.5mm, 2mm, 2.5mm & 3mm A/F.
- Imperial sizes 0.028", 0.036", 0.05", 1/16", 5/64", 3/32", 7/64", 1/8" & 9/64" A/F.
- Ideal for router cutters, modellers, engineers, automotive, DIY, electronics etc.



NEW



Product Ref.

HK/SET/A _____ **£4.50**

NO-VOLT RELEASE SWITCH 115 VOLT

NEW 2012

The main function is the remote switching of power tools such as routers when mounted in a router table and can be placed in a convenient position.

- Trips power to the machine should power be momentarily cut off.
- Plug cable 0.7 metre in length.
- Socket cable 0.5 metre in length.
- 16 amp plug and socket.
- Max. load 12 amp.
- Can be mounted to CRT/MK3.



115 VOLT

Product Ref.

NVRS/2/115V _____ **£45.00**

DOWEL CENTRE POINTS

NEW

Six pack of metal dowel centres that fit into blind holes to allow lining up of the mating hole for wooden dowels.

6MM, 8MM & 10MM DIA.

- Pairs of 6mm, 8mm and 10mm diameter dowel centres.
- Place end of dowel centre into holes drilled in one piece of wood. Place second piece of wood in required position and press to leave centre mark for the hole.



Product Ref.

DWL/C/PK1 _____ **£2.50**

DRILL COUNTERSINK WITH ROTATING STOP

Tungsten Carbide tipped drill countersink with non-marring rotating depth stop.

- Ideal for decking screws.
- Adjustable countersink depth.



NEW 2012

TCT

NEW METRIC DRILL SIZES

Product Ref.	Drill Ø	CB Ø	
SNAP/CSDS/4MMT	(4mm x 10mm)		£17.33
SNAP/CSDS/5MMT	(5mm x 12.7mm)		£22.00
SNAP/CSDS/6MMT	(6mm x 12.7mm)		£22.00
Spare Drill Bits Individual			
WP-SNAP/D/4MS	(4mmØ)		£2.63
WP-SNAP/D/5MS	(5mmØ)		£2.63
WP-SNAP/D/6MS	(6mmØ)		£2.63

Other sizes available. Please see catalogue.

8PC MASONRY DRILL SET

Milled one-piece Tungsten Carbide Tipped masonry drill set in tool holder.

- For building blocks, mortar and brickwork.
- Diameters 3mm, 4mm, 5mm, 5.5mm, 6mm, 6.5mm, 7mm & 8mm.
- Supplied in tool holder which has Velcro® backed elasticated cartridges to allow layout flexibility.



8 PIECE

NEW

TCT

Product Ref.	
SNAP/MD3/SET	£19.00

PROFESSIONAL DIAMOND SHARPENING

6" X 2" DOUBLE-SIDED WORKSHOP STONE

Continual diamond surface stone for sharpening, deburring and honing a wide range of tools.

- Double-sided fine/coarse 6" long x 2" wide.
- Ideal for workshop and site use. Fast, clean stock removal.
- Recommended for use by wood carvers.
- Continuous diamond and bonded to a precision flat pre-plated nickel carbon steel base.
- Supplied with non-slip mat, cleaning block and wallet.
- Use with Trend lapping fluid.
- Size: 152mm x 49mm x 8mm.



NEW 2012

PRECISION FLAT SUBSTRATE

Grade	Grit	Micron
◆ FINE	1000	11
◆ COARSE	300	45

Product Ref.	
DWS/W6/FC	£39.50

POZI® NO.2 DIAMOND 25MM INSERT BITS

NEW

Torsion zone tips are Diamond and Sapphire particle coated.

3 PACK

- Coating provides optimum torque transfer and secure grip on screw head.
- Nickel coated, hi-grade chrome-vanadium through hardened.



Product Ref.	
SNAP/IPZ2D/3	£5.90

SLOTTED 25MM INSERT BITS

Four popular sizes of slotted bits.

- Hi-grade chrome-vanadium through hardened for ultimate wear resistance.

3 PACK



Product Ref.		
SNAP/IS45/3	(4.5mm x 0.6mm)	£4.50
SNAP/IS55/3	(5.5mm x 0.8mm)	£4.50
SNAP/IS65/3	(6.5mm x 1.2mm)	£4.50
SNAP/IS8/3	(8mm x 1.6mm)	£4.50

MAGNETIC QUICK CHUCK

Magnetic chuck accepts Trend Snappy shank fittings and insert screwdriver bits.

- Magnet will hold wood screws when used with insert bits.
- 15mm diameter x 60mm long.

NEW PRICE

IMPROVED DESIGN WITH SMALLER BODY DIAMETER

Product Ref.	
SNAP/QCM	£12.90



HOLE COUNTERSINK

- Single flute 82 degree countersink for countersinking holes in wood and man-made boards.

Product Ref.	
SNAP/CSK/1	£9.98



CRAFTPRO **NEW** ROUTER TABLE MK3

The New CraftPro Router Table will suit tradesmen, craftsmen and woodworking enthusiasts. It is packed with the necessary features to maximise the versatility of all popular portable routers.

- Laminated MDF table top 610mm x 405mm x 26mm thick with steel legs for bench mounting. Bench height 410mm.
- Removable 6.35mm aluminium insert plate with a 98mm diameter aperture and two insert rings 31.8mm and 67.5mm diameter.
- Pre-drilled for Trend routers, plus for T11 router Quick Raiser and T11 quick release fixing holes.
- Adjustable quick release back-fence with sliding cheeks, clear safety guard and top pressure with 57mm diameter dust spout.
- Lead-on pin for bearing guided work.
- Edge planing facility of 1.4mm or 2.4mm.
- Includes 240 volt no-volt release switch, side finger pressure, pushstick and fully adjustable mitre fence.



Guard Assembly
Fully adjustable.



57mmØ Dust Spout Aperture



Aluminium Plate
6.35mm thick with levelling facility and lead-on pin.



Router and cutter not included.

Product Ref.	CRT/MK3 (240v)	£199.00
Accessories		
CRT/4	Hose with adaptor 39mm x 3 metre to allow fitting to a dust extractor.	
T30/22	Large diameter hose 57mm x 1.5 metre for use with T30 dust extractor.	
T11/JT/KIT	T11 router quick release kit to allow quick removal of T11 router.	

SAFETY FEATURES

- No-volt Release Switch
- Adjustable Top & Side Pressure
- Adjustable Safety Guard
- Sliding Fence Cheeks
- Two Insert Rings
- Pushstick



Edge Planing



Edge Moulding

VIEW A DISPLAY MODEL AT PARTICIPATING STOCKISTS AROUND THE UK.

See www.trend-uk.com

To fit the following routers directly:

TREND T5, T5 MK2, T9, T10, T11, BOSCH GOF1600A, 1700ACE, CMT CMT1E, 2E, DEWALT DW613, 614, 615, 620, 621, 624, 625E, 629, DRAPER PT1200V, ELU MOF96(E) MK2, 131, 177(E), OF97(E), MAKITA RP0910, 1110C, PERLES OF808(E) >1999

Removable aluminium centre plate of table will need to be re-drilled for other makes and models of routers.

Includes:

- 2 x Insert Rings
- 1 x No-volt Release Switch
- 1 x Mitre Fence
- 2 x Finger Pressures
- 1 x Safety Guard
- 1 x Lead-on Pin
- 1 x Pushstick

PROFESSIONAL BENCH STONE PROMOTION

Precision flat continual diamond surfaced stones for sharpening, deburring or honing a wide range of tools.

- Monocrystalline diamond allows clean stock removal.
- Fast, easy to use, durable and versatile.
- Trend Lapping Fluid recommended.

Size and Grade	Product Ref.	Price
7" DOUBLE-SIDED BENCH STONE ◆ Fine 1000 grit ◆ Coarse 340 grit	DWS/B7/FC	NOW £59.50 (was £79.50)
8" DOUBLE-SIDED BENCH STONE ◆ Fine 1000 grit ◆ Coarse 340 grit	DWS/W8/FC	NOW £79.50 (was £89.50)
8" SINGLE-SIDED BENCH STONE ◆ Fine 1000 grit	DWS/W8/F	NOW £59.50 (was £69.50)
◆ Coarse 340 grit	DWS/W8/C	NOW £59.50 (was £69.50)
◆ Extra Coarse 220 grit	DWS/W8/X	NOW £59.50 (was £69.50)



Ideal for:
Planer Blades



Chisels



Knives & Scissors



Use with Lapping Fluid

DIAMOND WHETSTONE KIT

A diamond whetstone kit suitable for sharpening a wide variety of tools.

Includes:

- DWS/B7/FC** 7" x 2.5" bench stone with non-slip mat and tool pouch
- DWS/CC/FC** Credit card stone
- DWS/LF/100** Lapping fluid
- DWS/BH/B7** Bench holder
- DWS/CB/A** Cleaning block

Product Ref.	DWS/KIT/A	NOW £87.50 (was £109.00)
---------------------	------------------	------------------------------------



All prices are exclusive of VAT

SPECIAL OFFERS WHILE STOCKS LAST

USER MAKE VACUUM BEDS

Allows user to make their own vacuum bed, which provides obstruction free clamping for all edge routing, hand planing, batten free belt sanding etc.

- Ref. BMACH/KIT allows construction of bed sizes 1120mm x 520mm.
- Ref. MMACH/KIT allows construction of bed sizes 259mm x 482mm.
- Not suitable with cyclone extractors.

BMACH/KIT comprises of two x 2.3m of bottom and four x 2.3m of top gasket, vacuum control tap assembly, tapered adapter & 21 ball valves.

MMACH/KIT comprises of one x 2.3m of bottom and two x 2.3m of top gasket, vacuum control tap assembly, tapered adapter & 12 ball valves.



Product Ref.

BMACH/KIT £14.90
MMACH/KIT £9.90

T60 CORDLESS GLUE GUN

Electronic cordless cartridge hot melt glue gun with heating station.

- Immediate initial bond, high final bond strength.
- Polyurethane (PUR) glue for bonding ceramics, marble, metal, glass, wood, various plastics.
- Includes 50g PUR glue cartridge.



Product Ref.

T60 NOW £19.99
(was £59.00)

NOVA TIP SET

Multi-Profile Router Cutter System.

- A variety of interchangeable solid carbide blades.
- The Nova System uses replaceable solid carbide blades offered in a number of profile shape options.
- 1/2" shank.



Includes 5 shapes.
25 extra shapes
available at
£5.00 each.
See website
for details.

TCT

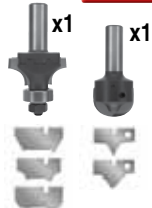

Product Ref.

NT/SET/ABX1/2 £29.00

MITRE FENCE PLASTIC BODY

For use with user made router tables, saw benches and band saws.

- Angles -60 degree 0 degree, + 60 degree.
- Scale pitch of 5 degree.
- Protractor body 102mm x 28mm high with metal bar 200mm x 17mm.
- Beech splch block included.



Product Ref.

MITRE/2 NOW £9.00
(was £11.03)

DOLLS HOUSE CUTTERS

1/12th scale dolls house moulding cutters.

- High Speed Steel for a very fine edge.
- It is adjustable to use in a router table with a small aperture table top and fence.
- For skirting and architraves.

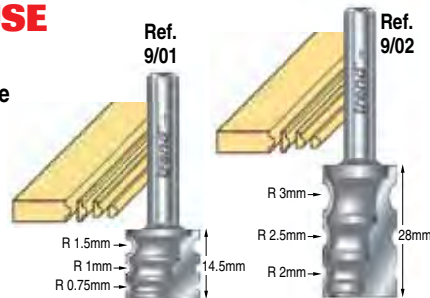

HSS

Ref. 45/12

Ref. 45/13

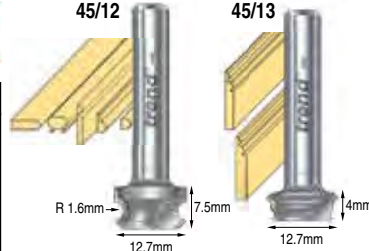

Product Ref.

9/01X1/4HSS £4.90
9/02X1/4HSS £4.90
45/12X1/4HSS £4.90
45/13X1/4HSS £4.90

See www.trend-uk.com for details

All prices are exclusive of VAT

© Copyright Trend 2012. Our policy of continuous improvement means that specifications may change without notice. Trend Machinery and Cutting Tools cannot be held liable for any material rendered unusable or any form of consequential loss. E&OE
® All trademarks acknowledged.

Trend Machinery & Cutting Tools Ltd.
Odhams Trading Estate
St Albans Road Watford
WD24 7TR England
Tel: 0044(0)1923 249911
enquiry@trendm.co.uk
www.trend-uk.com

trend
routing technology