

Parts Information:
**Professional Pressure Washer 160bar with
 TSS & Nozzle Set 230V
 Model No: PW5000.V2**

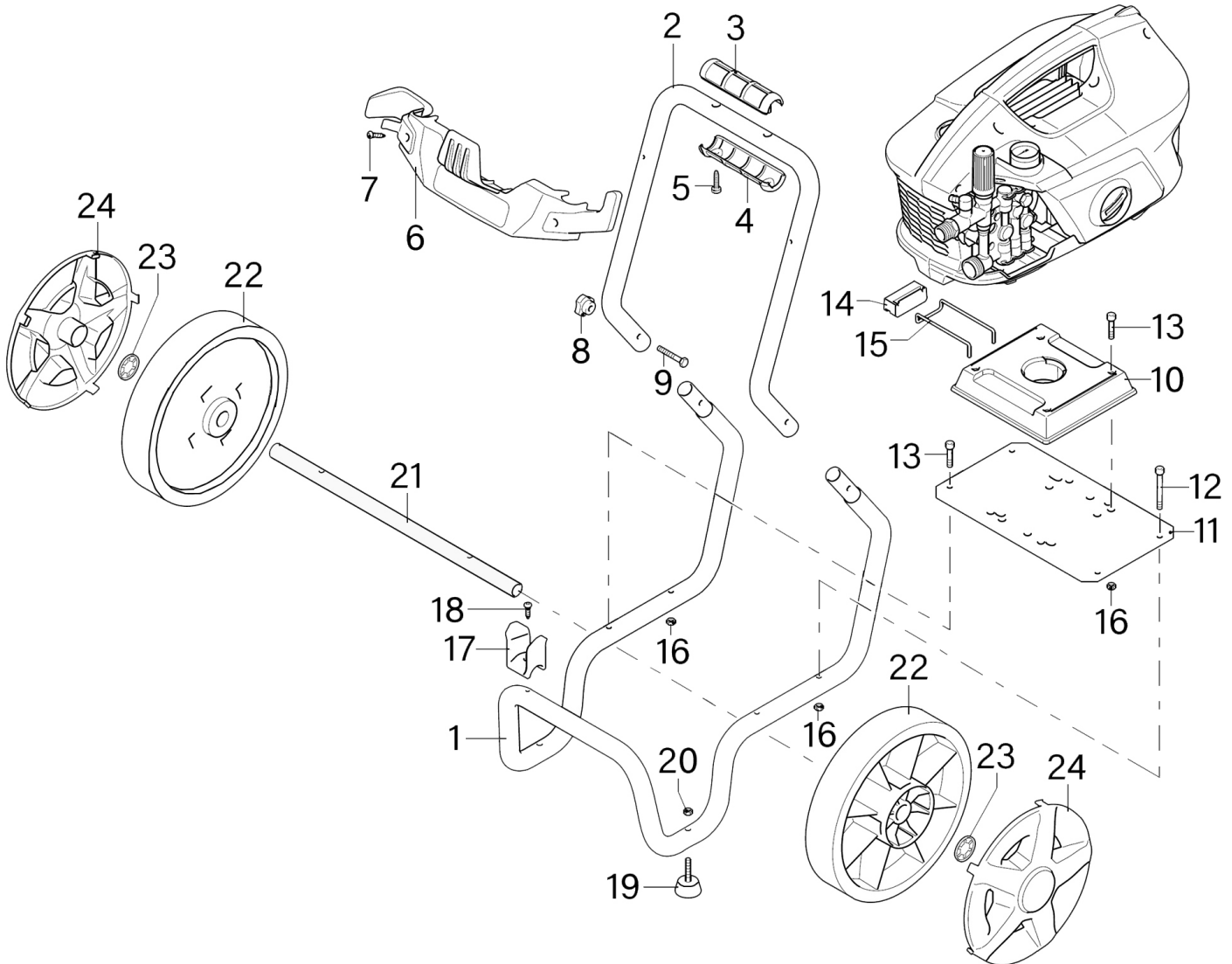

Item	Part No.	Description	Qty
1	181-4320010	Lower Frame	1
2	181-4320020	Upper Frame	1
3	181.3580180	Handle Guard (Upper)	1
4	181.3580090	Handle Guard (Lower)	1
5	181/2100300	Rd Head S/T Screw M4.8 X 16 Black	2
6	181-4320050	Accessory Holder Faceplate (Black)	1
7	181.2060200	Rd Head S/T Screw M4.6 X 16 Black	2
8	181.50019	Knob, Plastic, OD: 30mm ID: 9mm, M5 Threaded Female Fitting	2
9	SS640.S	Hex Head Set Screw M6 X 40 Zinc	1
10	181-1345370	Base For Quick Attachment	1
11	181-4320030	Base Plate	1
12	181-2480310	Socket Cap Bolt M5 x 55	2

Item	Part No.	Description	Qty
13	SCB540.SB	Socket Cap Screw M5 x 40mm Black	6
14	181-1345360	Release Button	1
15	181-1345470	Spring Clip for Quick Attachment	1
16	SN5.S	Steel Nut M5 Zinc	8
17	181.3600070	Carrier Bracket	1
18	181.2060200	Rd Head S/T Screw M4.6 x 16 Black	1
19	181-4320220	Anti-Vibration Foot M6 x 33	2
20	SN6.S	Steel Nut M6 Zinc	2
21	181-4320040	Wheel Axle	1
22	181-4320280	Wheel, Fixed Plastic	2
23	181.380620	Washer	2
24	181-4320271	Wheel Cover	2

NOTE: It is our policy to continually improve products and as such we reserve the right to alter data, specifications and component parts without prior notice. There may be alternative versions of this product, please contact us should you require this information.

IMPORTANT: No liability is accepted for incorrect use of product. Spare parts must be fitted by a competent person

WARRANTY: Guarantee is 12 months from purchase date, proof of which will be required for any claim.

Parts Information:
**Professional Pressure Washer 160bar with
 TSS & Nozzle Set 230V
 Model No: PW5000.V2**

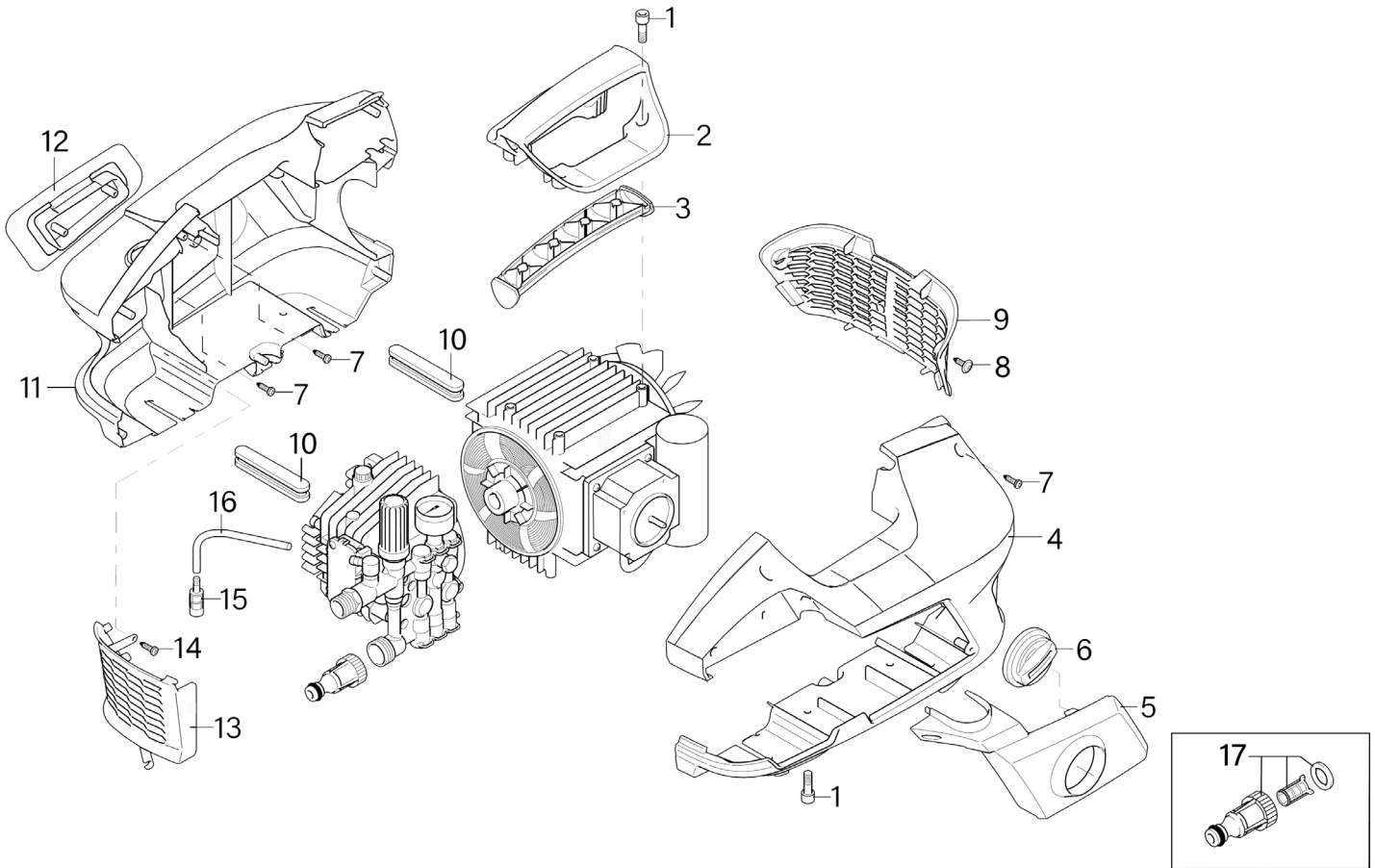

Item	Part No.	Description	Qty
1	SCB620.S	Socket Cap Bolt M6 x 20mm	8
2	181-1345340	Handle, Motor	1
3	181-1345350	Handle Cover, Lower	1
4	181-1345270	Side Cover, Right (for Motor)	1
5	181-1345330	Side Plate for Switch	1
6	181-1345420	Switch Knob	1
7	181/2100300	Rd Head S/T Screw M4.8 X 16 Black	10
8	181-4240590	Self-Tapping Screw 5x16	2
9	181-1345310	Rear Protection Grille	1

Item	Part No.	Description	Qty
10	181-4240540	Lower Anti-Vibration Bar	2
11	181-1345280	Side Cover, Left (for Motor)	1
12	181-1345292	Side Plate for Detail Hose	1
13	181-1345300	Front Protection Grille	1
14	181/1261570	Screw	1
15	181/1341030	Filter, Detergent Pick-Up	1
16	181.1270960	Detergent Hose	1
17	181.3082130	Water Coupling	1

NOTE: It is our policy to continually improve products and as such we reserve the right to alter data, specifications and component parts without prior notice. There may be alternative versions of this product, please contact us should you require this information.

IMPORTANT: No liability is accepted for incorrect use of product. Spare parts must be fitted by a competent person

WARRANTY: Guarantee is 12 months from purchase date, proof of which will be required for any claim.

Parts Information: Professional Pressure Washer 160bar with TSS & Nozzle Set 230V Model No: PW5000.V2

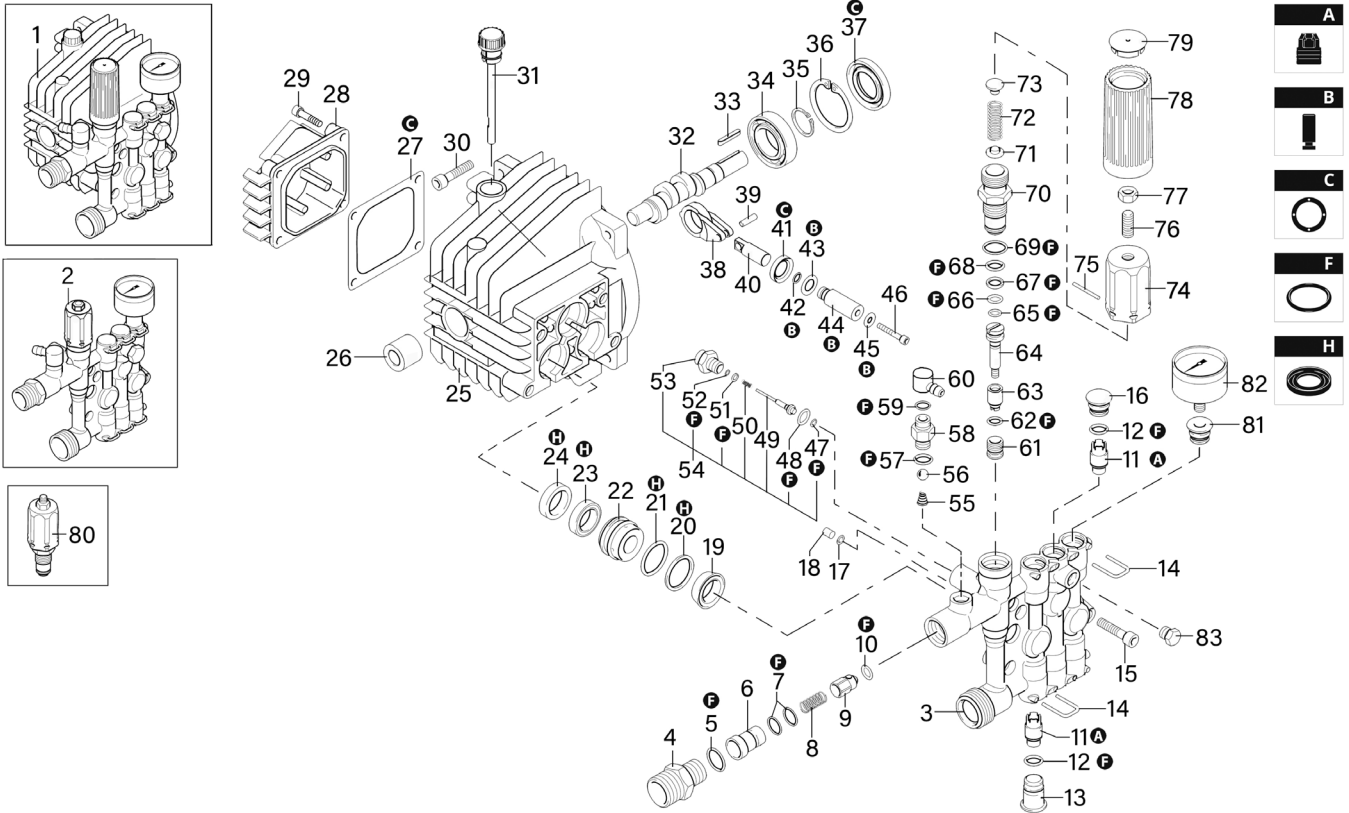

Item	Part No.	Description	Qty
1	181-1349538	Pump Assembly Complete	1
2	181-1349133	Pump Head Assembly	1
3	181-1345160	Pump Head with Integral Valve	1
4	181.2840400	Fitting	1
5	VS3900.03	O-Ring, (Ex: 17.56 In: 14 Cs: 1.78)	1
6	181.2901110	Injector	1
7	DH03.V2-39	O-Ring, (Ex: 12.81 In: 9.25 Cs: 1.78)	2
8	181-3780450	Spring	1
9	181.2901070	Shutter	1
10	181/1460430	O-Ring	1
11	181-1349056	Unloader Valve	6
12	181/1465720	O-Ring	6
13	181-1345040	End Plug	3
14	181.1344790	U-Pin	6
15	SCB630.S	Socket Cap Bolt M6 x 30	4
16	181.1344800	End Plug	2
17	SA77S.V4-19	O-Ring, (Ex: 8.03 In: 4.47 Cs: 1.78)	1
18	181.1344890	Plug	1
19	181-3200690	Water Seal	3
20	181-3200700	O-Ring	1

Item	Part No.	Description	Qty
21	181/770260	O-Ring, (Ex: 27.08 In: 23.52 Cs: 1.78)	3
22	181-1345190	Piston Guide	3
23	181/1260440	Gasket	3
24	181.1344760	Seal Ring	3
25	181/1344050	Casing, Regulator End	1
26	181-1345210	Needle Bearing NK1516	1
27	181.1040710	O-Ring, (Ex: 60.43 In: 56.87 Cs: 1.78)	1
28	181.1344060	Side Cover	1
29	181/1260780	Screw	1
30	181/1260780	Screw	4
31	181.1349000	Dipstick	1
32	181/1340170	Cam Shaft	1
33	181/880111	Key	1
34	B/6303	Bearing 6303	1
35	181/480890	Circlip, External	1
36	181.111120	Internal Circlip 50.06mm OD.	1
37	181/1341080	Seal	1
38	181/1340060	Cam	3
39	181/1340080	Pin	3
40	181/1340070	Piston	3

NOTE: It is our policy to continually improve products and as such we reserve the right to alter data, specifications and component parts without prior notice. There may be alternative versions of this product, please contact us should you require this information.

IMPORTANT: No liability is accepted for incorrect use of product. Spare parts must be fitted by a competent person

WARRANTY: Guarantee is 12 months from purchase date, proof of which will be required for any claim.



Parts Information:
**Professional Pressure Washer 160bar with
 TSS & Nozzle Set 230V
 Model No: PW5000.V2**

Item	Part No.	Description	Qty
41	181/1260460	Seal	3
42	181/600180	O-Ring, (Ex: 11.21 In: 7.65 Cs: 1.78)	3
43	181/1341010	Washer	3
44	181/1342740	Piston	3
45	181/1341020	Washer	3
46	181/850670	Screw	3
47	181/1120680	O-Ring	1
48	181/600180	O-Ring, (Ex: 11.21 In: 7.65 Cs: 1.78)	1
49	181.2022040	Valve Pin	1
50	181.2021630	Valve Spring Dia 6.06mm	1
51	181.2021650	Valve Washer/Spacer	1
52	181/1260820	O-Ring	1
53	181.1344830	Fitting	1
54	181.42580	Tss Kit	1
55	181/1560520	Spring Dia 4.6mm	1
56	SB-5.6	Steel Ball 5.6mm	1
57	SA77S.V4-19	O-Ring, (Ex: 8.03 In: 4.47 Cs: 1.78)	1
58	181-1344620	Hose Fitting 1/8"	1
59	181.480560	O-Ring	1
60	181.2320180	Hose Tail	1
61	181.1342701	Piston Seat	1
62	181/600180	O-Ring, (Ex: 11.21 In: 7.65 Cs: 1.78)	1
63	181.1460151	Piston	1
64	181.2021900	Piston	1
65	SA401.03	O-Ring, (Ex: 6.46 In: 2.90 Cs: 1.78)	1

Item	Part No.	Description	Qty
66	181/600180	O-Ring, (Ex: 11.21 In: 7.65 Cs: 1.78)	1
67	181/1080401	Spring Washer 11mm O/D	1
68	SA342.12	O-Ring, (Ex: 14.38 In: 10.82 Cs: 1.78)	1
69	VS3900.03	O-Ring, (Ex: 17.56 In: 14 Cs: 1.78)	1
70	181.1344870	Piston Guide	1
71	181.1343450	Spring Plate	1
72	181/1460190	Spring	1
73	181/1980220	Spring Plate	1
74	181.1344881	Top Cover	1
75	181/1080070	Pin	1
76	GSM620.S	Grub Screw M6x20 (Single)	1
77	SN6.S	Steel Nut M6 Zinc	1
78	181/1981780	Knob, Regulator, Plastic, OD: 30mm L: 61mm, 22mm Hex Female	1
79	181/1981770	Cap	1
80	181-42690	Pressure Regulator Valve Kit	1
81	181-1345020	Gauge Support	1
82	181-41851	Pressure Gauge	1
83	181/620301	Plug	1
A	181-KIT42691	Unloader Valve Kit	1
B	181/KIT 2623	Piston Kit	1
C	181-KIT42696	Seal Kit	1
F	181-KIT42697	O-Ring Kit	1
H	181-KIT43033	Water Seal Kit	1

NOTE: It is our policy to continually improve products and as such we reserve the right to alter data, specifications and component parts without prior notice. There may be alternative versions of this product, please contact us should you require this information.

IMPORTANT: No liability is accepted for incorrect use of product. Spare parts must be fitted by a competent person

WARRANTY: Guarantee is 12 months from purchase date, proof of which will be required for any claim.

Sealey Group, Kempson Way, Suffolk Business Park, Bury St Edmunds, Suffolk. IP32 7AR



01284 757500



sales@sealey.co.uk



www.sealey.co.uk

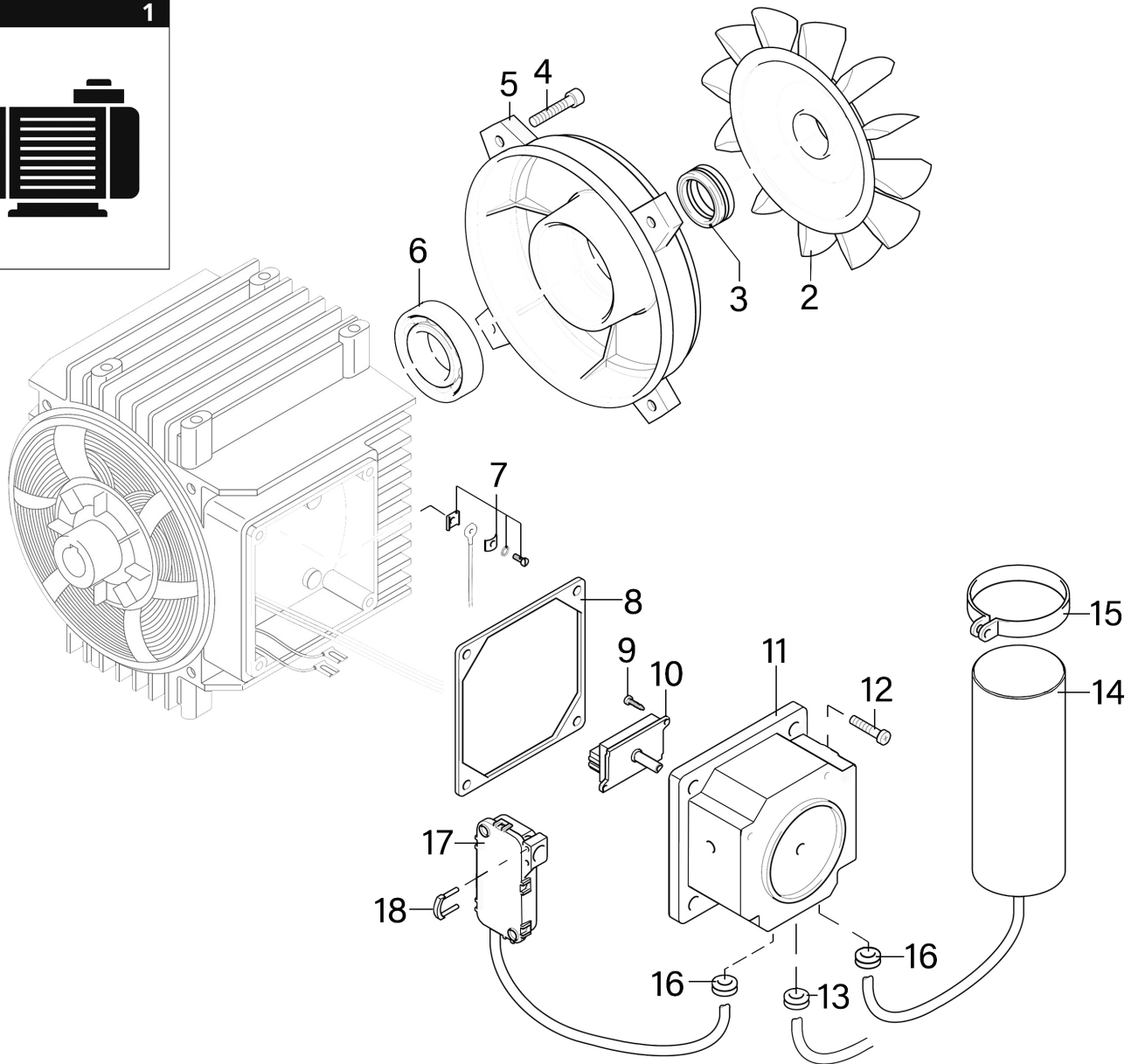
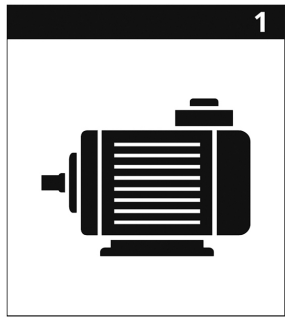

Item	Part No.	Description	Qty
1	181-45068	Motor Assembly	1
2	181/1260300	Fan, Motor	1
3	181/1340350	Spacer	1
4	SCB520.S	Socket Cap Bolt M5 x 20mm	4
5	181/1340320	Housing	1
6	B/6204ZZ	Bearing 6204Zz	1
7	181/1269100	Connection	1
8	181/1340780	Gasket	1
9	181-2000210	Self-Tapping Screw 4x10	2

Item	Part No.	Description	Qty
10	181-2901920	Rotary Switch 16A 250V	1
11	181-3780170	Switch Box	1
12	181/1261560	Phillips Screw M4x16	4
13	181/2021480	Gland	1
14	181/1263520	Capacitor (40Uf)	1
15	181-1982550	Capacitor Clip	1
16	181-1462900	Cable Grip	2
17	181.2029752	Tss Ass'y	1
18	181.2022201	U-Pin	1

NOTE: It is our policy to continually improve products and as such we reserve the right to alter data, specifications and component parts without prior notice. There may be alternative versions of this product, please contact us should you require this information.

IMPORTANT: No liability is accepted for incorrect use of product. Spare parts must be fitted by a competent person

WARRANTY: Guarantee is 12 months from purchase date, proof of which will be required for any claim.



Parts Information:
**Professional Pressure Washer 160bar with
TSS & Nozzle Set 230V
Model No: PW5000.V2**

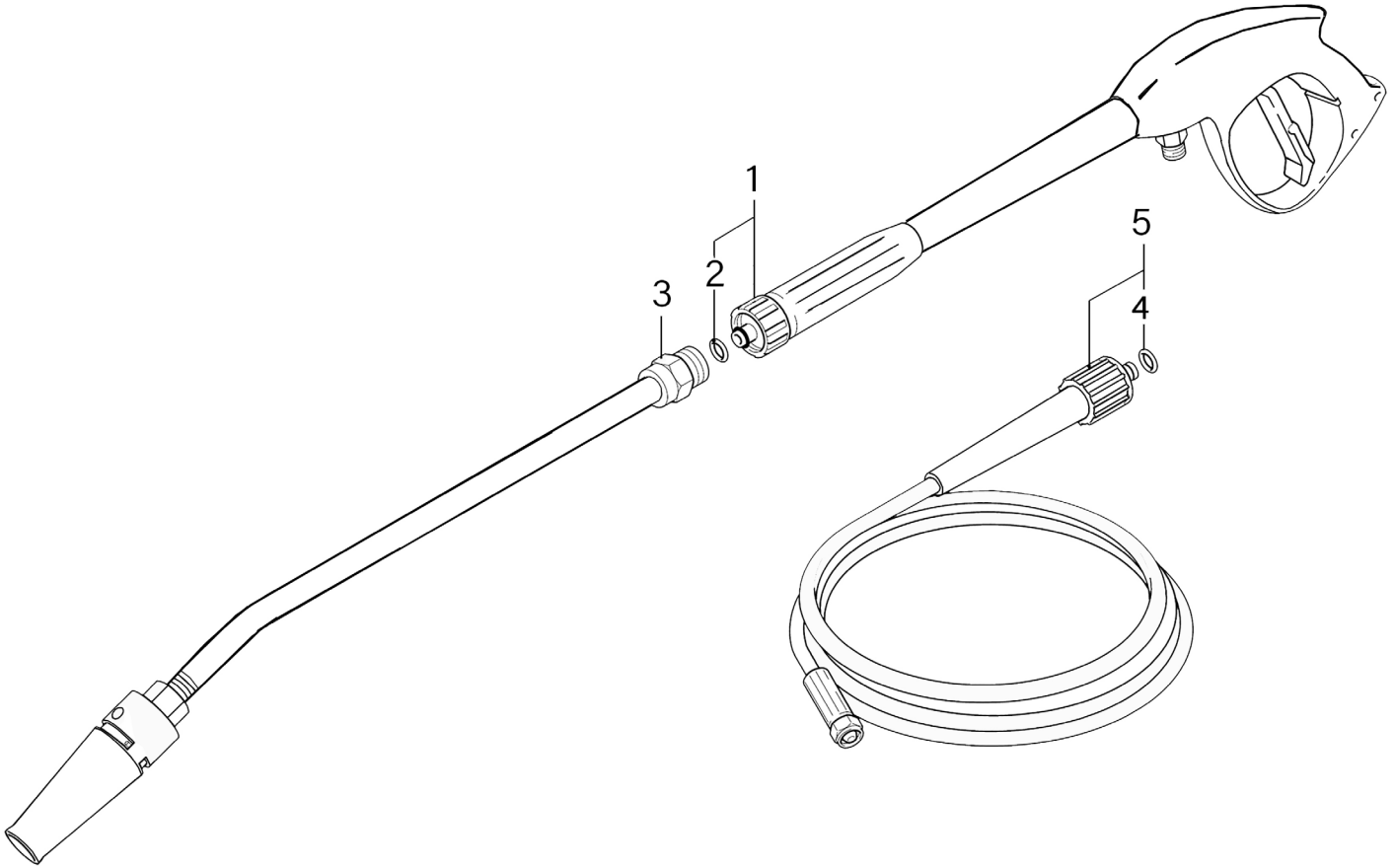

Item	Part No.	Description	Qty
1	181.40925	Gun	1
2	181/391000	O-Ring, (Ex: 14.43 In: 9.31 Cs: 2.56)	1
3	181-41269	Pressure Lance	1

Item	Part No.	Description	Qty
4	181.2000570	O-Ring, Green, (Ex: 13.77 In: 10.21 Cs: 1.78)	1
5	181-3780491	Pressure Hose 8m	1

NOTE: It is our policy to continually improve products and as such we reserve the right to alter data, specifications and component parts without prior notice. There may be alternative versions of this product, please contact us should you require this information.

IMPORTANT: No liability is accepted for incorrect use of product. Spare parts must be fitted by a competent person

WARRANTY: Guarantee is 12 months from purchase date, proof of which will be required for any claim.

Sealey Group, Kempson Way, Suffolk Business Park, Bury St Edmunds, Suffolk. IP32 7AR



01284 757500



sales@sealey.co.uk



www.sealey.co.uk