

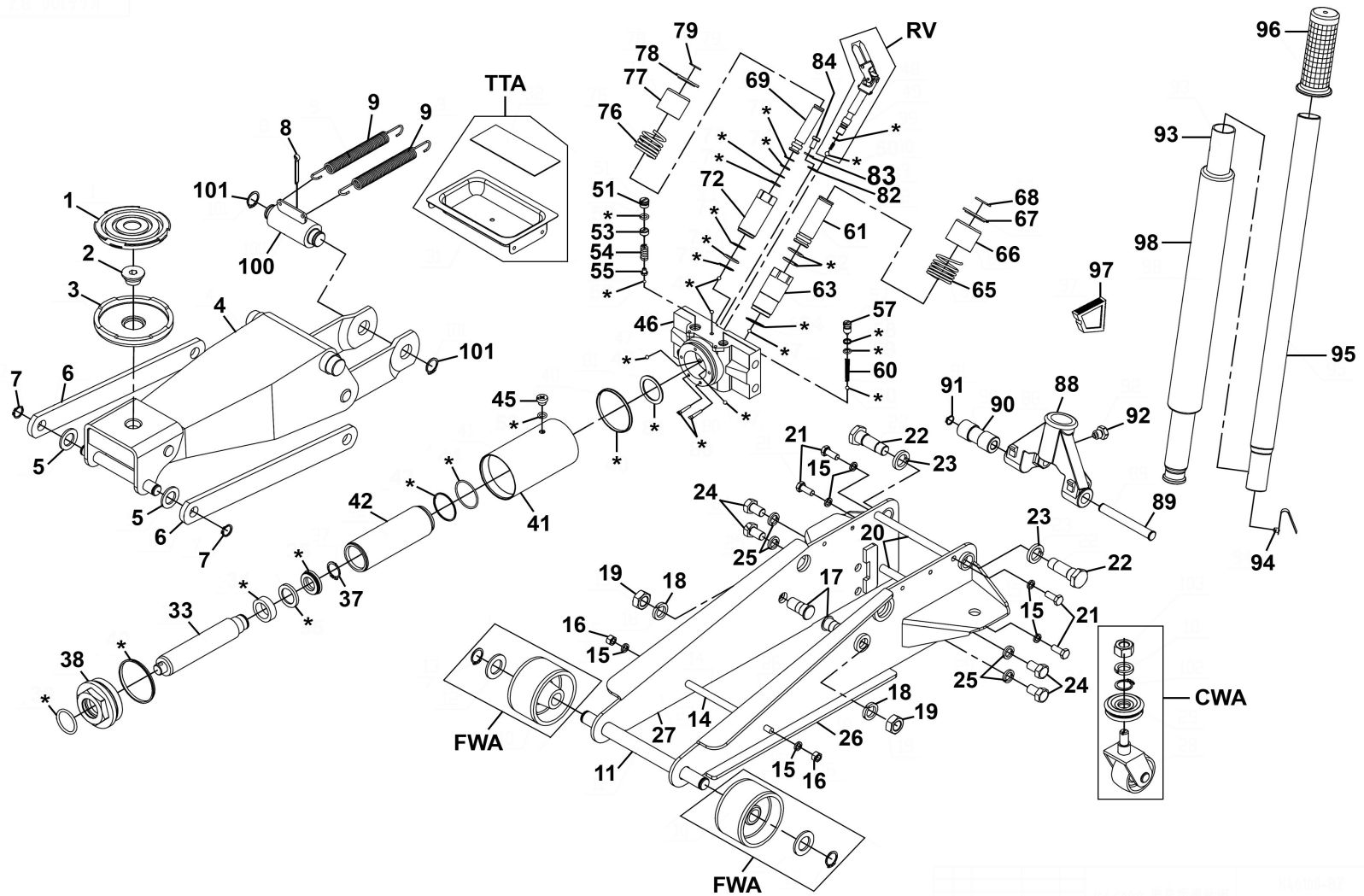

Parts Information:
Trolley Jack 3 Tonne Super Rocket Lift
Model No: 3015CXD.V4 & 3015CXHV.V3



NOTE: It is our policy to continually improve products and as such we reserve the right to alter data, specifications and component parts without prior notice.

There may be alternative versions of this product, please contact us should you require this information.

IMPORTANT: No liability is accepted for incorrect use of product. Spare parts must be fitted by a competent person

WARRANTY: Guarantee is 12 months from purchase date, proof of which will be required for any claim.

Sealey Group, Kempson Way, Suffolk Business Park, Bury St Edmunds, Suffolk. IP32 7AR



01284 757500



sales@sealey.co.uk



www.sealey.co.uk



Parts Information:
Trolley Jack 3 Tonne Super Rocket Lift
Model No: 3015CXD.V4 & 3015CXHV.V3

Item	Part No.	Description	Qty
1	JP17	Safety Rubber Jack Pad - Type B	1
2	4040A.02	Saddle Pin	1
3	3001CXP.03	Saddle	1
4	SQ0396	Lift Arm Assembly	1
5	FWM18.S	Flat Washer M18 Zinc	2
6	SQ0162	Radius Link	2
7	SQ0027	External Circlip 16.0mm ID.	2
8	SQ0200	Cotter Pin	1
9	SQ0185	Return Spring Dia 16mm	2
11	SQ0166	Front Axle	1
14	SQ0168	Frame Tie Rod	1
15	SWM8.S	Spring Washer M8 Zinc	6
16	SN8.S	Steel Nut M8 Zinc	2
17	SQ0189	Radius Link Stud	2
18	SWM16.S	Spring Washer M16 Zinc	4
19	NLN16.S	Nyloc Nut M16 Zinc	2
20	SQ0190	Frame Tie Rod	2
21	SS820.S	Hex Head Set Screw M8 X 20 Zinc	4
22	SQ0205	Handle Sleeve Bolt	2
23	SWM18.S	Spring Washer M18 Zinc	2
24	SS1220.S	Hex Head Set Screw M12 X 20 Zinc	4
25	SWM12.S	Spring Washer M12 Zinc	4
26	SQ0397	Frame, Left Side	1
27	SQ0398	Frame, Right Side	1
33	SQ0195	Ram Plunger	1
37	2500LE.V3-39	External Circlip 20.5mm ID.	1
38	SQ0199	Top Nut	1
41	SQ0201	Reservior	1
42	SQ0203	Cylinder	1
45	3001CXP.49	Oil Filler Plug Screw	1
46	SQ0425	Base	1
51	SQ0426	Guard Screw	1
53	SQ0427	Safety Valve Screw	1
54	SQ0428	Safety Valve Spring	1
55	SQ0429	Ball Seat Valve	1
57	SQ0384	Valve Screw	1

Item	Part No.	Description	Qty
60	2500LE.V3-62	Taper Spring Dia 8.4mm	1
61	4040TB.73	Pump Piston (B)	1
63	SQ0229	Pump Cylinder (large)	1
65	2500LE.V3-67	Pump Core Spring (B) Dia 37.4mm	1
66	2500LE.V3-68	Spring Sleeve (B)	1
67	2500LE.V3-69	Spring Stop Plate (B)	1
68	2500LE.V3-70	Spring Stop Plate Ring (B)	1
69	2500LE.V3-71	Pump Piston (A)	1
72	2500LE.V3-74	Pump 'A'	1
76	2500LE.V3-78	Pump Core Spring (A) Dia 33.5mm	1
77	2500LE.V3-79	Spring Sleeve (A)	1
78	2500LE.V3-80	Spring Stop Plate (A)	1
79	4040A.78	Snap Ring	1
82	2500LE.V3-84	Flat Washer (26 x 17 x T3)	1
83	SWM6.S	Spring Washer M6 Zinc	1
84	SS612.S	Hex Head Set Screw M6 X 12 Zinc	1
88	SQ0234	Handle Socket	1
89	2500LE.V3-91	Handle Socket Pin	1
90	SQ0236	Handle Socket Roller	1
91	2500LE.V3-93	External Circlip 12.0mm ID.	1
92	4040A.87N	Handle Socket Bolt	1
93	SQ0387	Upper Handle	1
94	2001LERE.V2-92	Handle Lock Button	1
95	SQ0388	Lower Handle	1
96	2500LE.V3-98	Handle Grip	1
97	SQ0354	Handle Locking Block	1
98	2500LE.V3-100	Handle Sleeve	1
100	SQ0430	Connection Rod	1
101	2500LE.V3-39	External Circlip 20.5mm ID.	2
CWA	3015CXD-V4-CWA	Wheel,Rear Swivel Castor, Single Bolt	2
FWA	3015CXD-V4-FWA	Wheel Assembly, Front, Fixed	2
RV	3015CXD-V4-RV	Release Valve Assembly	1
TTA	3015CXD-V4-TTA	Tool Tray Assembly	1
--	3015CXD-V4-HU	Hydraulic Unit Complete (not shown)	1
--	3015CXD-V4-RK	Repair Kit (all items marked *)	1

3015CXHV.V3

Item	Part No.	Description	Qty
4	SQ0163	Lift Arm Assembly (Hi-Vis)	1
26	SQ0214	Frame, Left Side (Hi-Vis)	1
27	SQ0383	Frame, Right Side (Hi-Vis)	1

Item	Part No.	Description	Qty
CWA	3015CXHV-V3-CWA	Wheel,Rear Swivel Castor, Single Bolt (PU)	2
FWA	3015CXHV-V3-FWA	Wheel Assembly, Front, Fixed (PU)	2

NOTE: It is our policy to continually improve products and as such we reserve the right to alter data, specifications and component parts without prior notice. There may be alternative versions of this product, please contact us should you require this information.

IMPORTANT: No liability is accepted for incorrect use of product. Spare parts must be fitted by a competent person

WARRANTY: Guarantee is 12 months from purchase date, proof of which will be required for any claim.

Sealey Group, Kempson Way, Suffolk Business Park, Bury St Edmunds, Suffolk. IP32 7AR



01284 757500



sales@sealey.co.uk



www.sealey.co.uk